

ЗАНИМАТЕЛЬНАЯ МАТЕМАТИКА

Рабочая тетрадь

Сколько предметов на рисунке. Напиши.

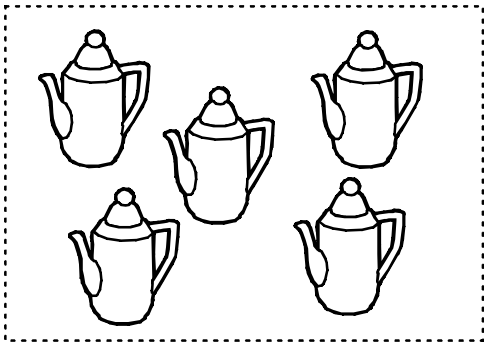
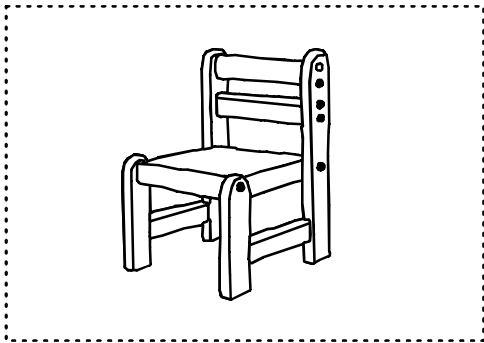
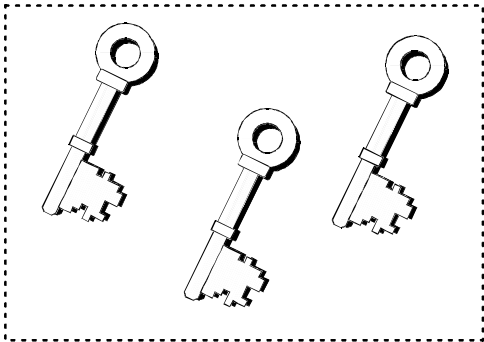
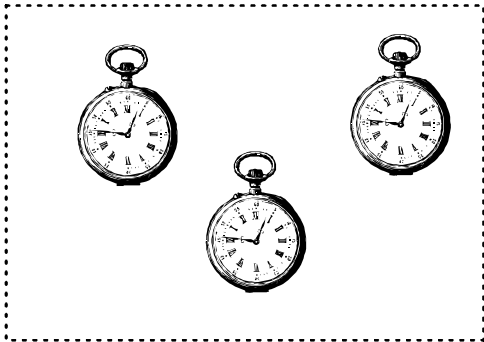
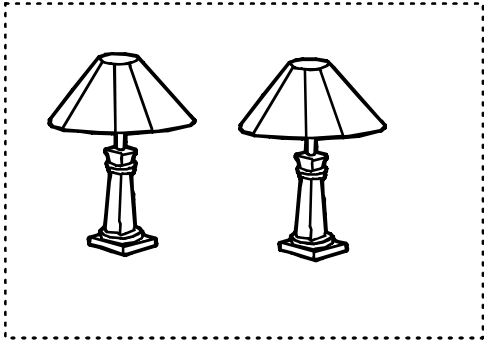
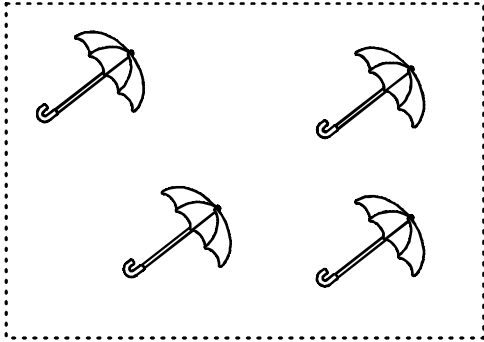

Обведи цифры, соедини их с соответствующими кубиками.

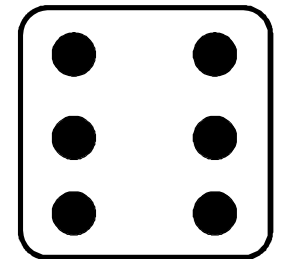
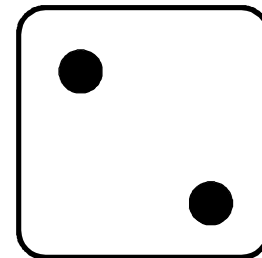
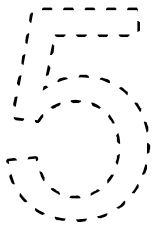
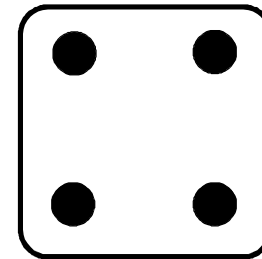
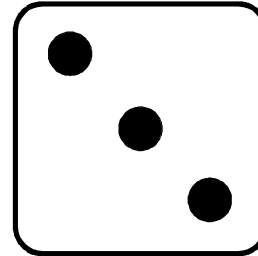
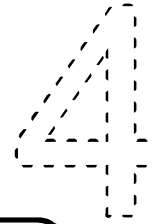
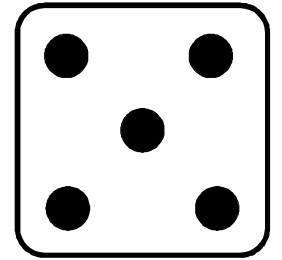
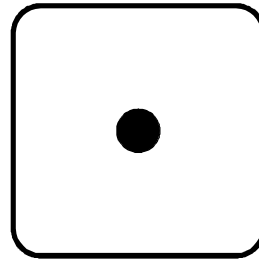

Какие геометрические фигуры, ты заметил?

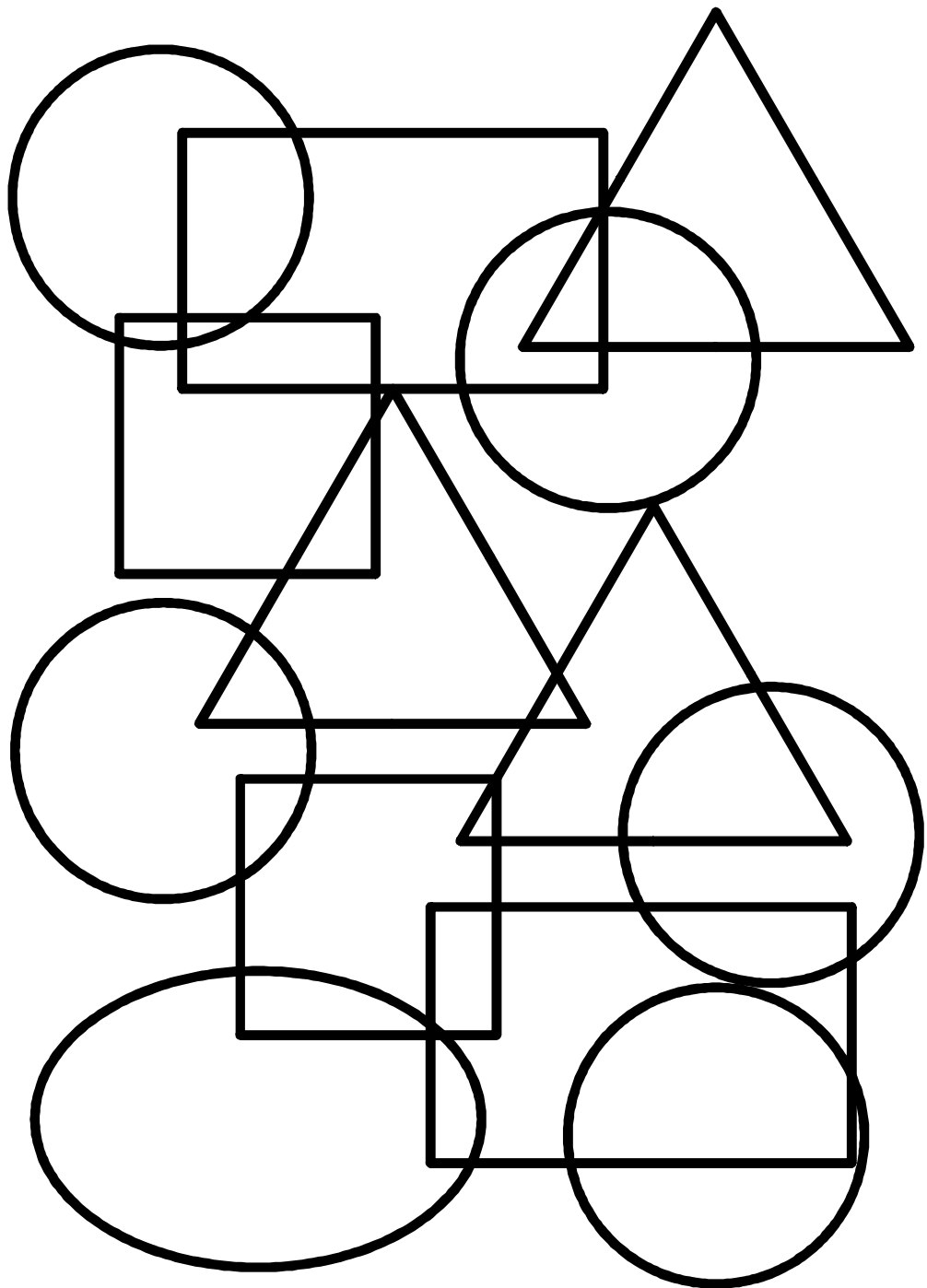

Каких предметов много, каких по одному.
Раскрась самый большой.

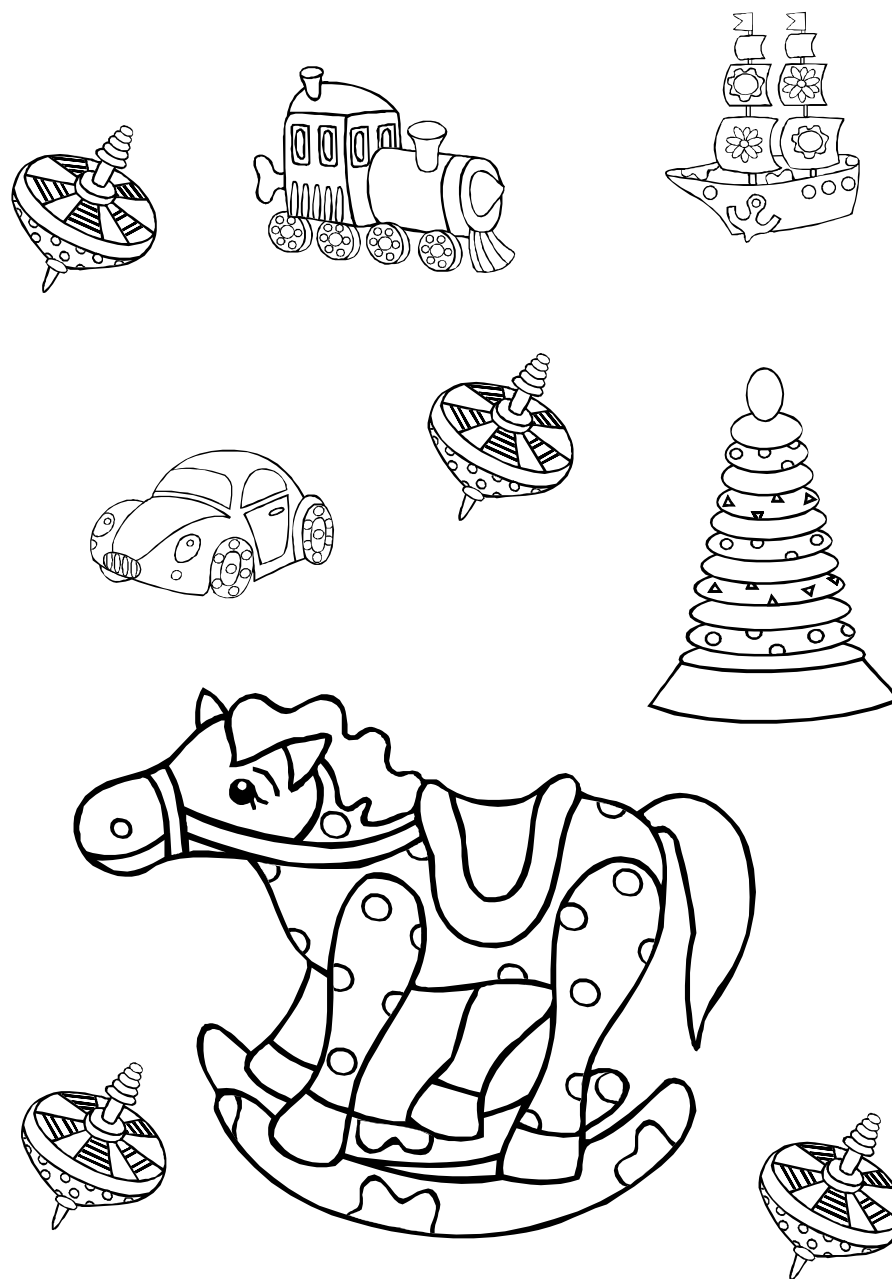

Нарисуй столько любимых предметов,
сколько показывает цифра.

3

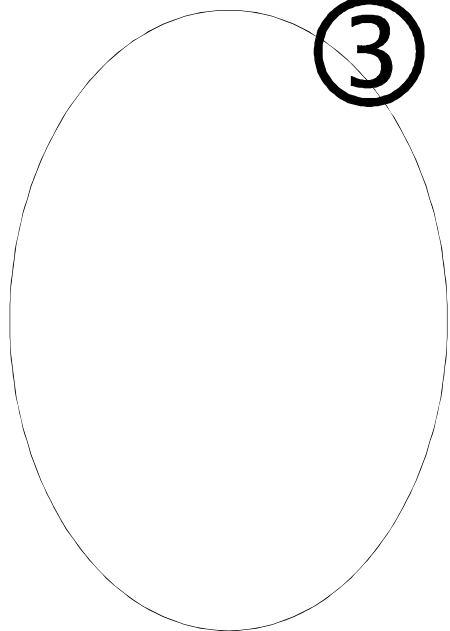

4

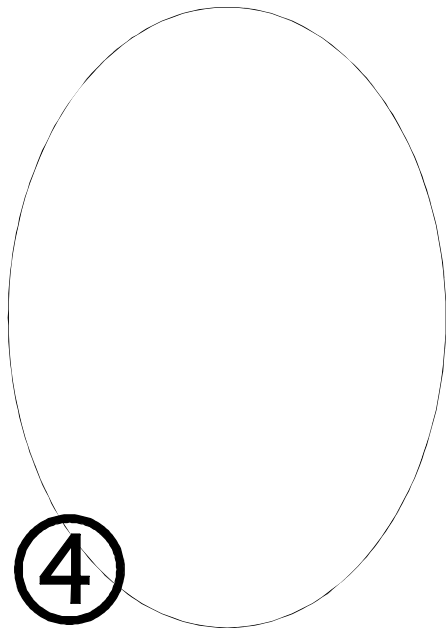

1

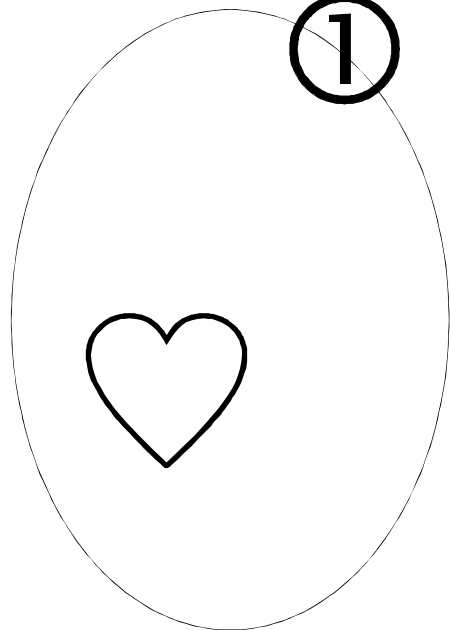

2

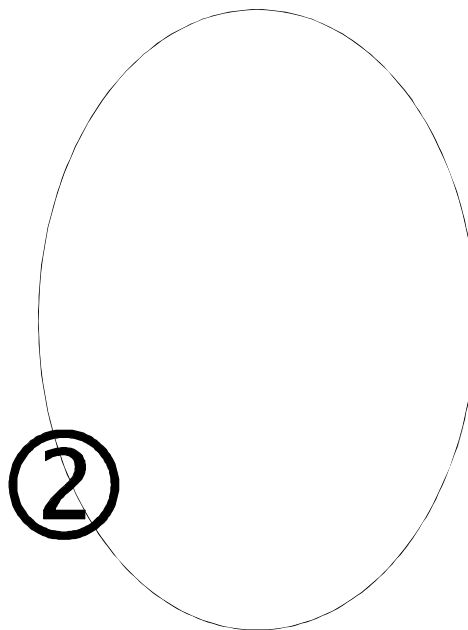

Дорисуй в каждой группе столько предметов,
чтобы их стало по пять.

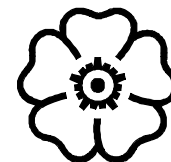
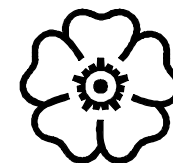

Раскрась по цифрам.

- 1 — зелёным, 2 — красным,
- 3 — розовым, 4 — жёлтым,
- 5 — синим, 6 — коричневым,
- 7 — красным.

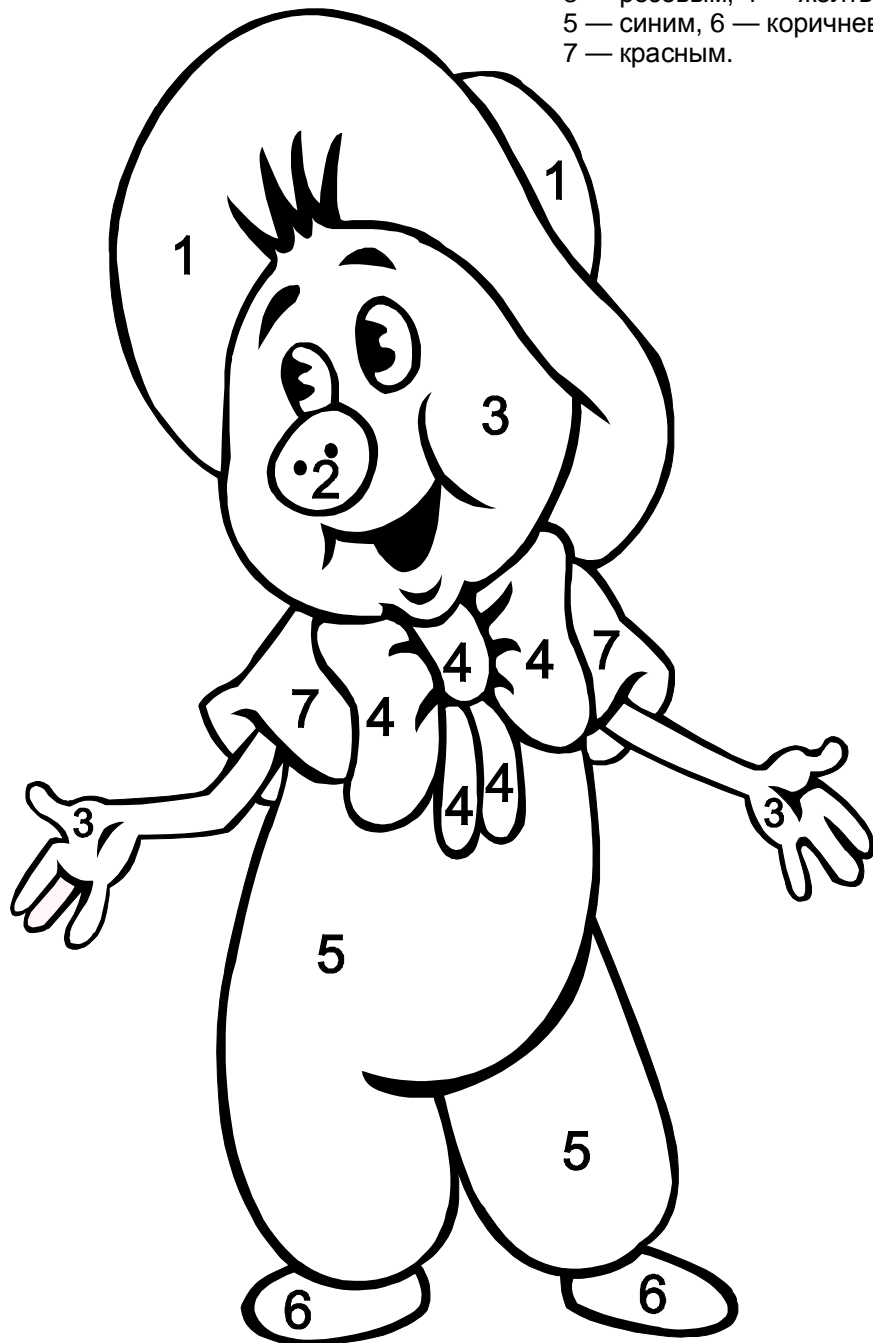

Раскрась по цифрам.

- 1 — красным, 2 — синим,
- 3 — коричневым, 4 — жёлтым,
- 5 — зелёным.

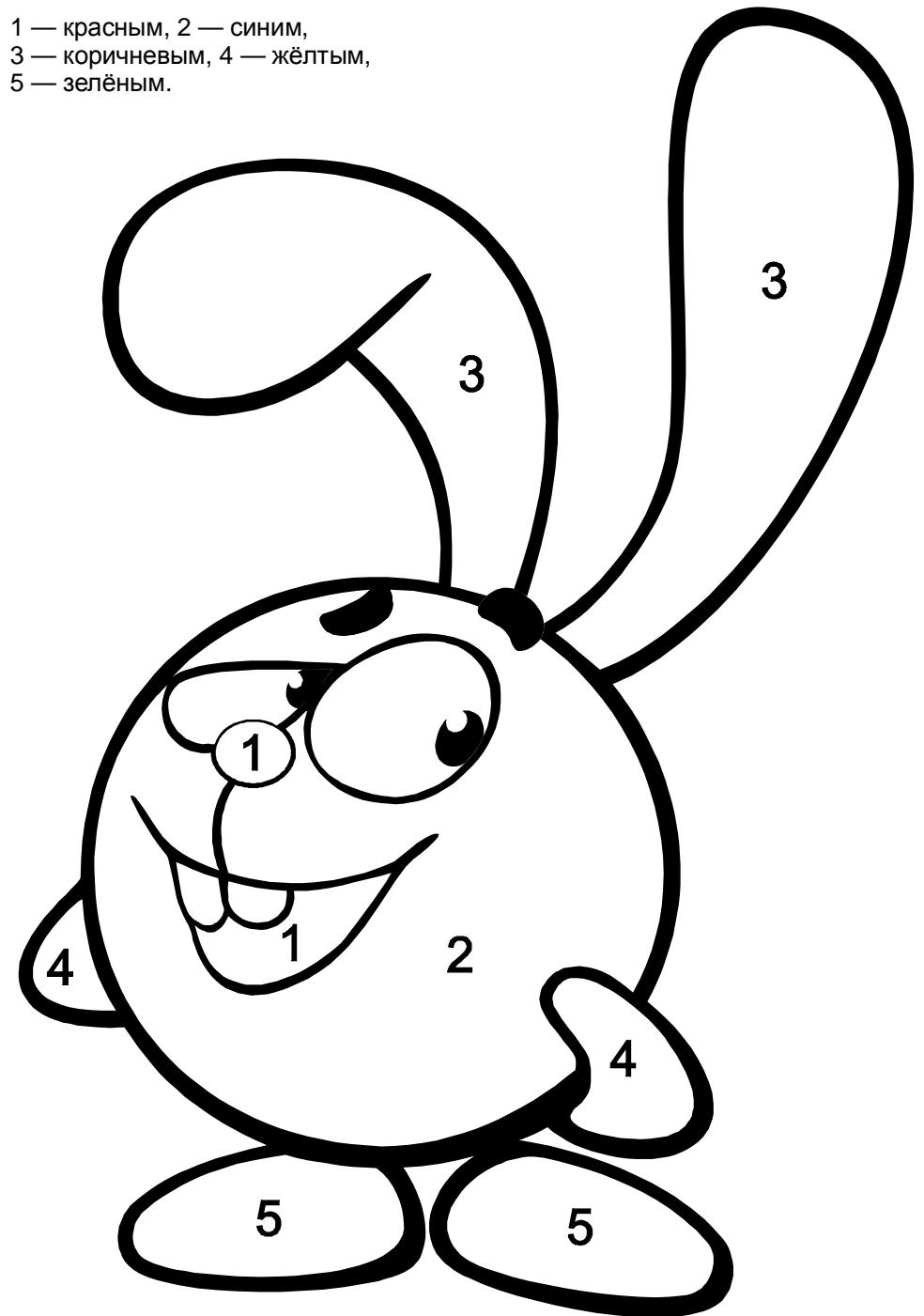

Раскрась самую длинную ленту красным цветом,
самую короткую — синим, самую широкую — жёлтым,
самую узкую зелёным.

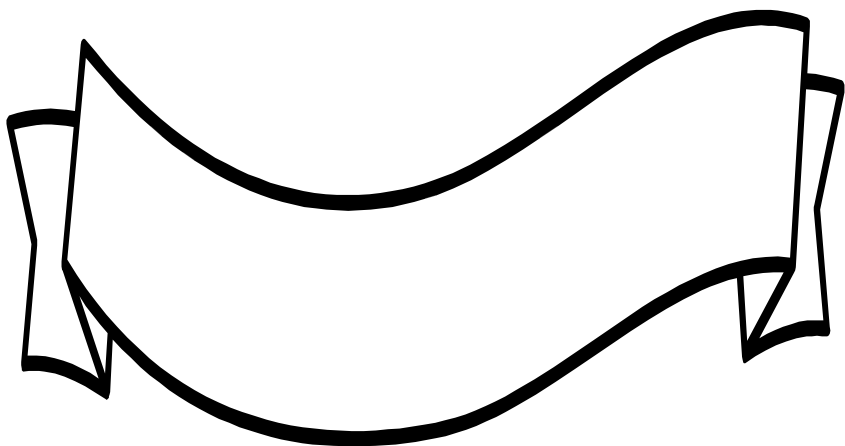
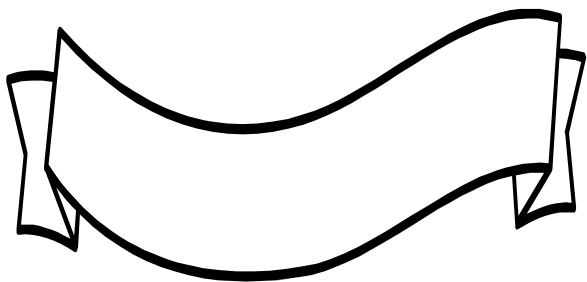

Найди крышку для каждой коробки.

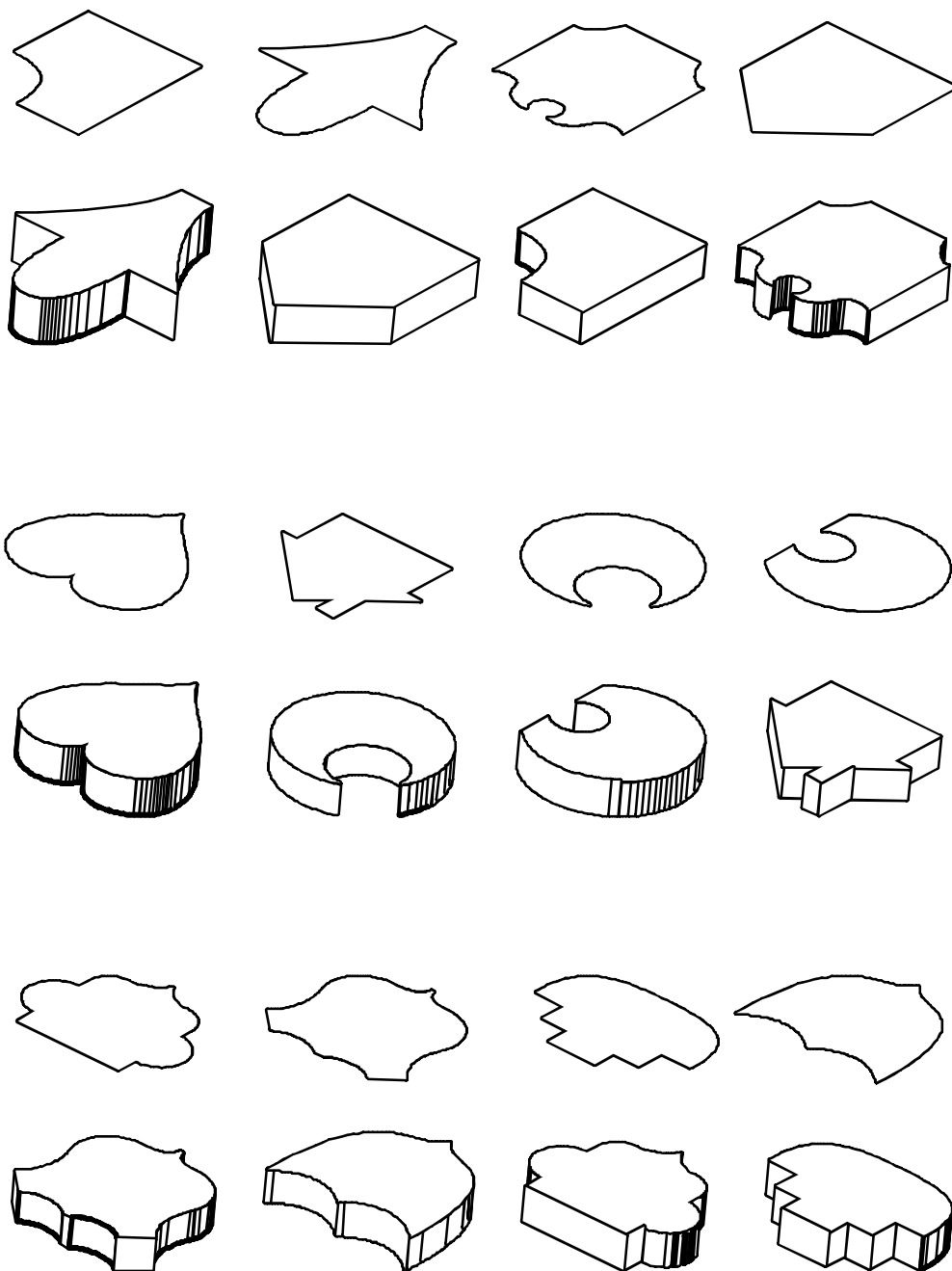

В каждом ряду раскрась столько фигур,
сколько указано цифрой.

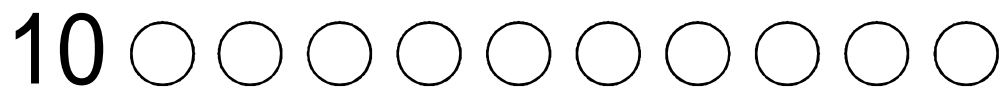
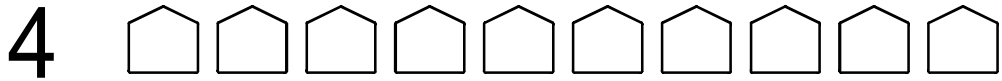
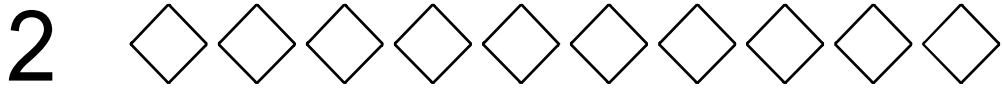
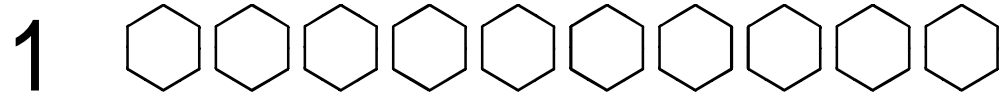

Соедини цифру с соответствующей картинкой.

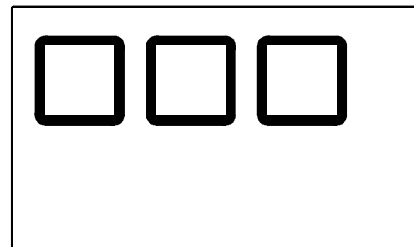
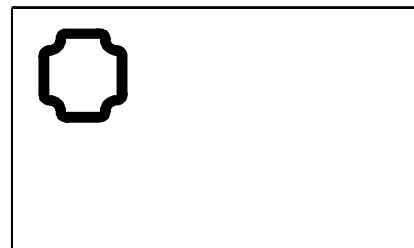
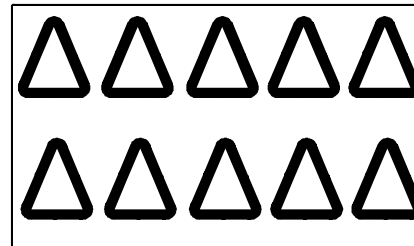
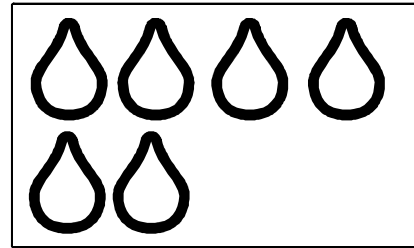
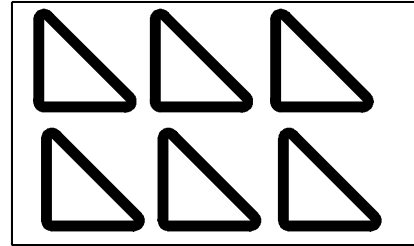

1

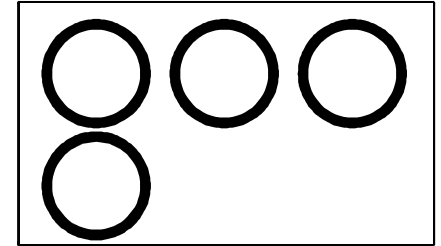

2

3

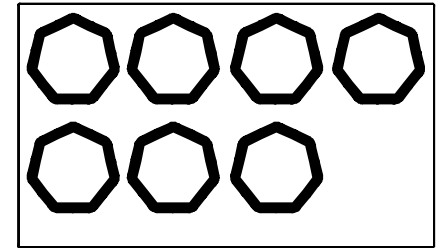

4

5

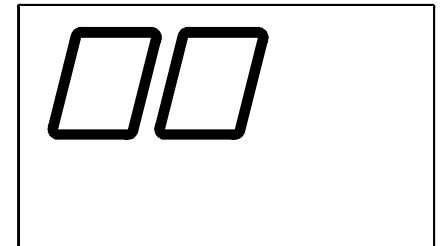

6

7

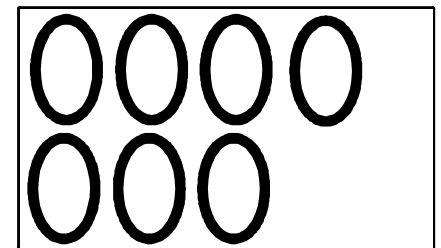

8

9

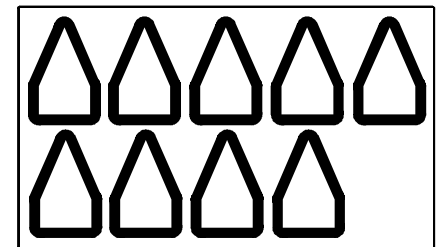

10

Помоги мальчику найти цифру 7.

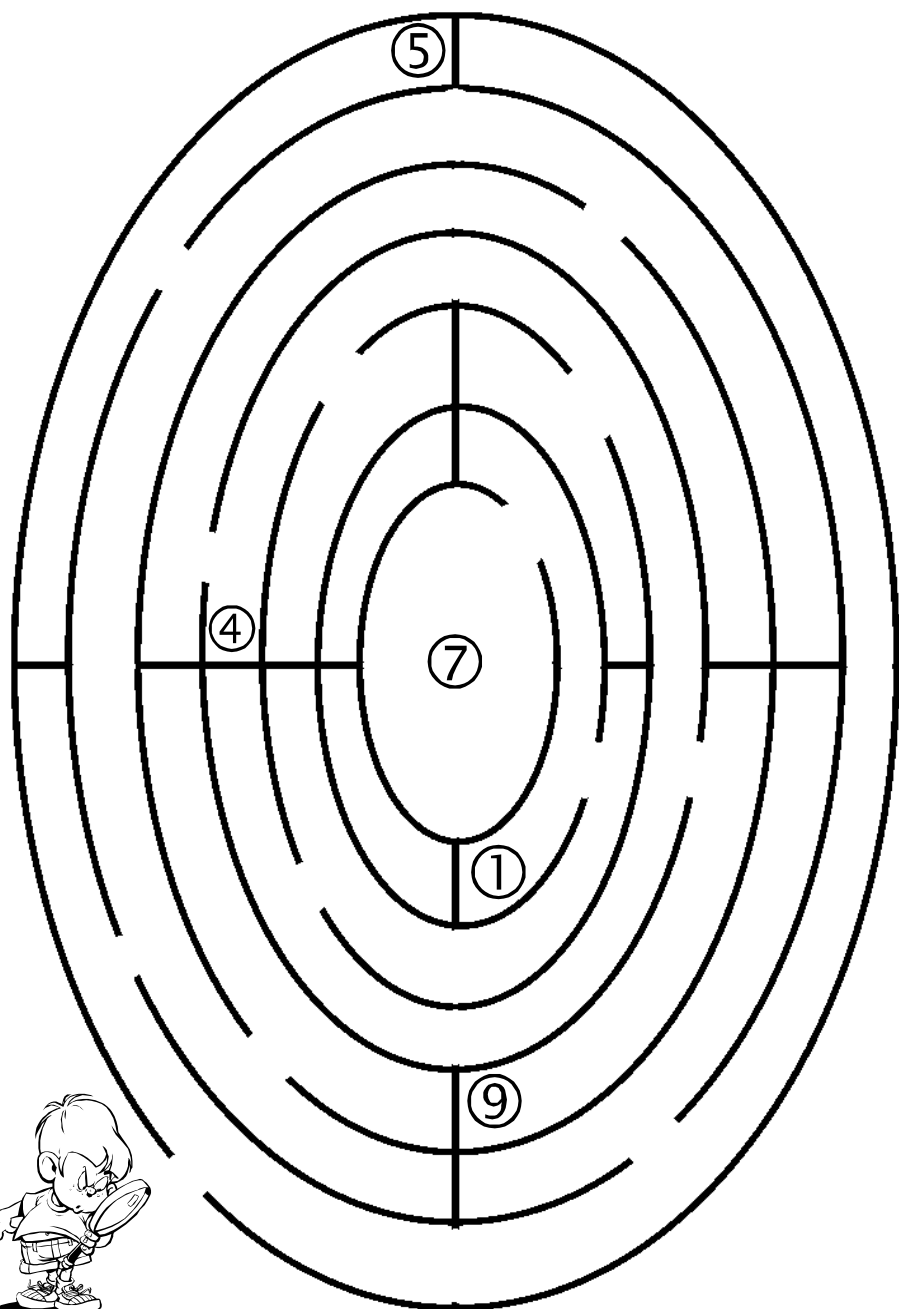

Собери все цифры.

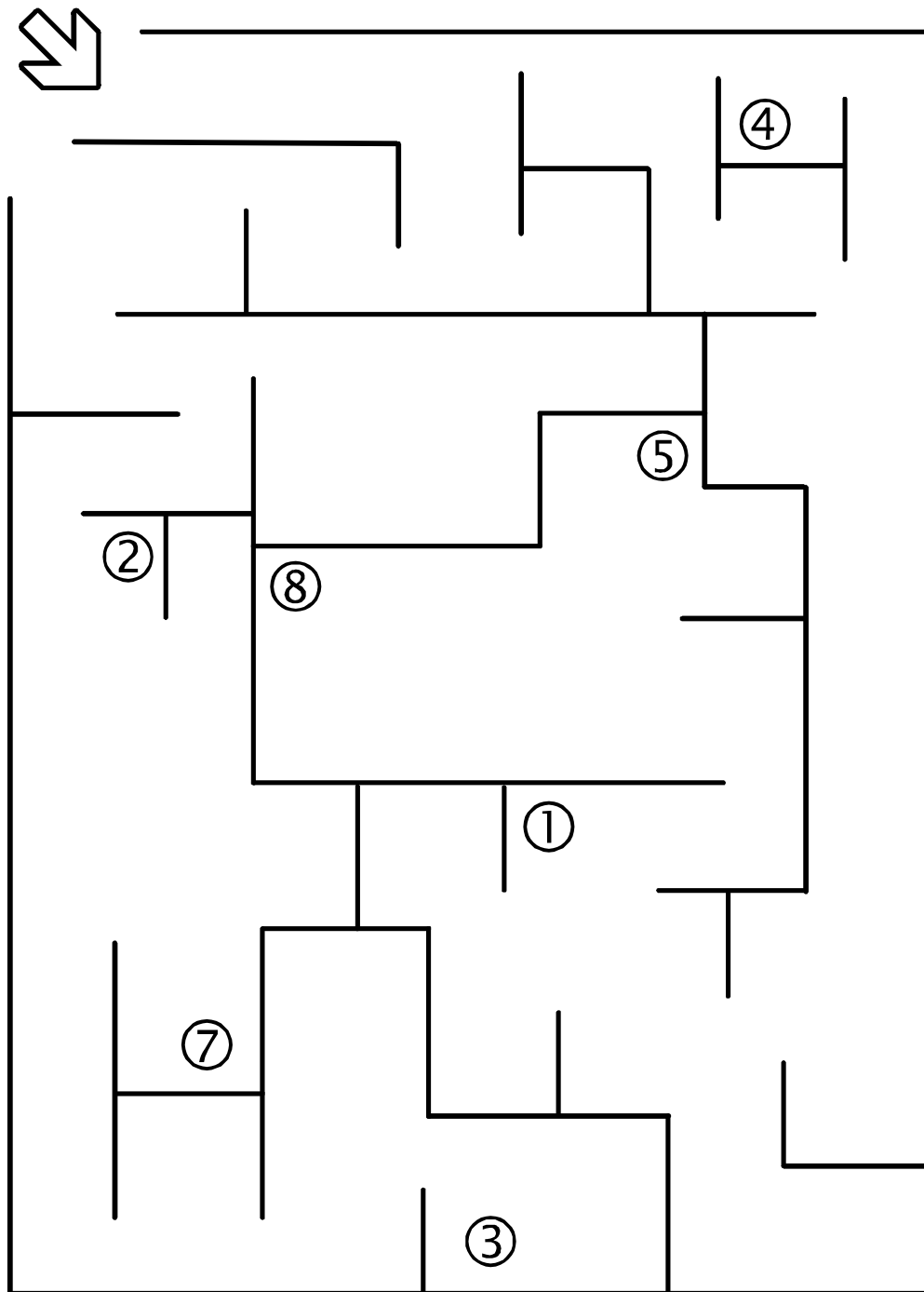

Найди и зачеркни "0 1 2" (по горизонтали).

Найди и зачеркни "5 4 5" (по горизонтали).

1	3	0	2	0	1	2	9	8	8	3	0	7	0	1	5	4	5
7	4	1	8	0	1	2	5	0	7	4	5	5	4	5	2	3	0
0	3	3	0	9	0	1	2	4	1	3	5	4	5	0	1	9	3
7	0	1	2	3	3	6	2	1	5	4	3	2	5	4	5	2	0
2	3	6	7	7	0	1	2	3	9	3	8	7	7	5	4	5	7
4	9	0	1	4	7	0	1	2	4	5	4	5	4	2	2	1	2
3	9	0	0	6	0	1	2	2	5	5	4	5	7	0	1	3	0

Какие цифры ты здесь видишь?

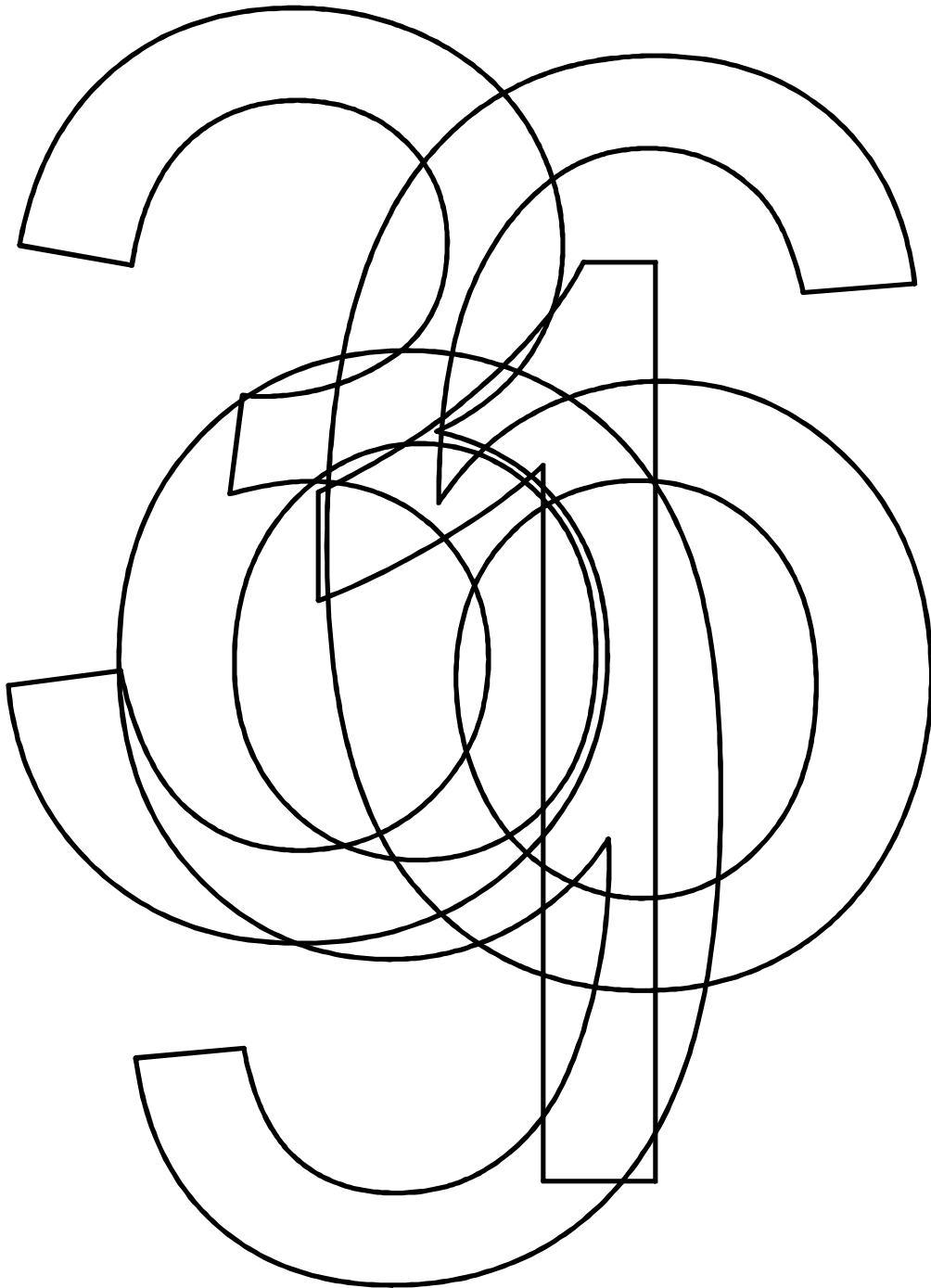

Какие цифры ты здесь видишь?

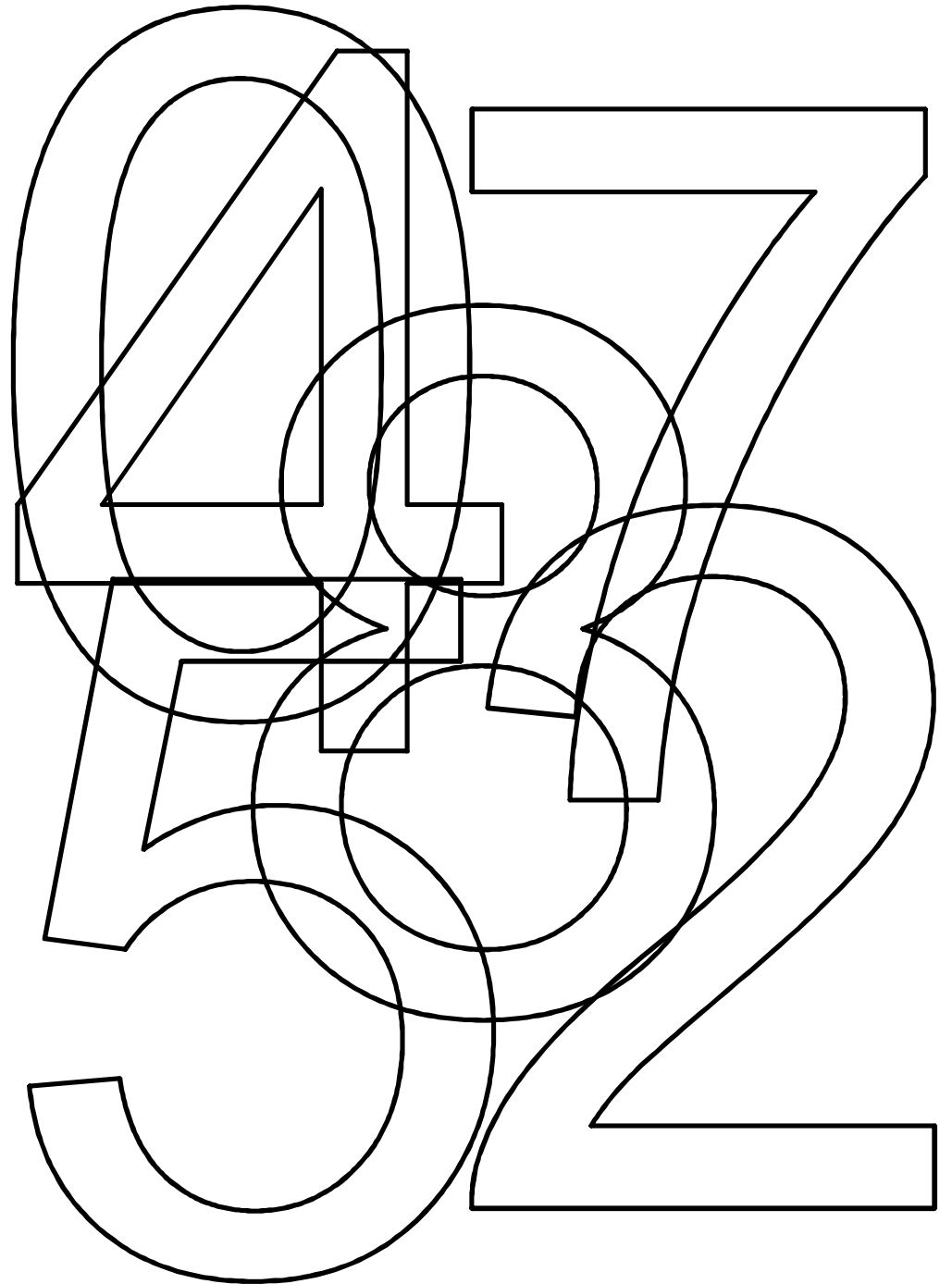

Раскрась одинаковые фигуры одним цветом.

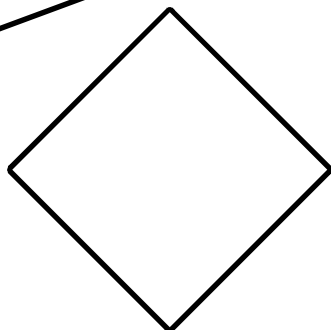
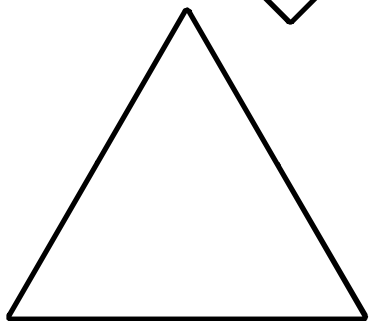
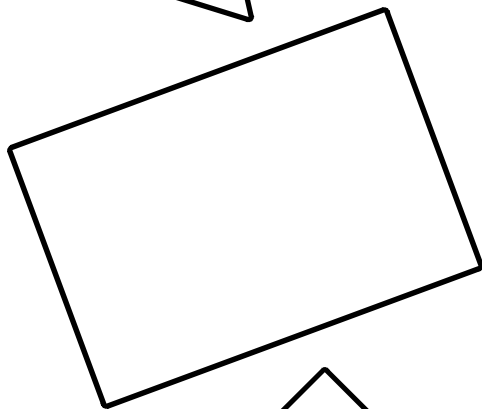
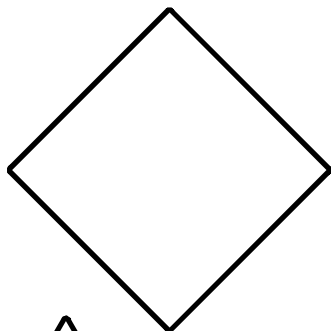
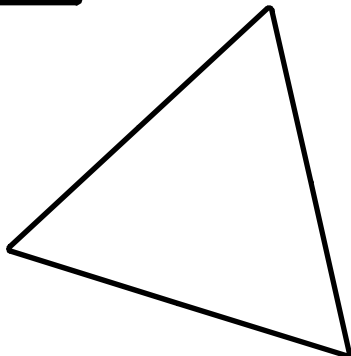
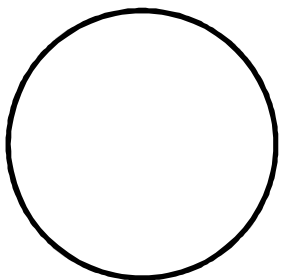
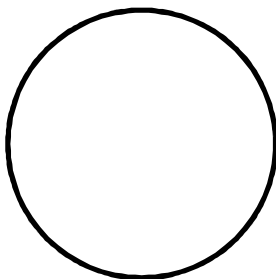

Раскрась одинаковые фигуры одним цветом.

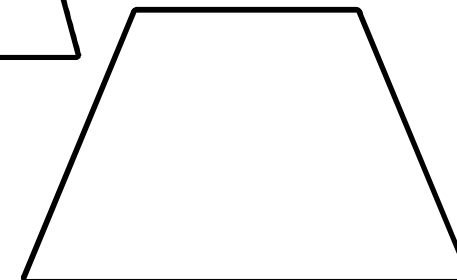
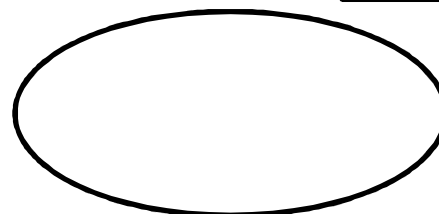
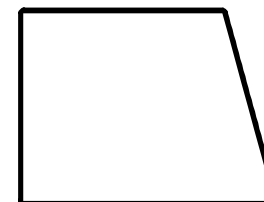
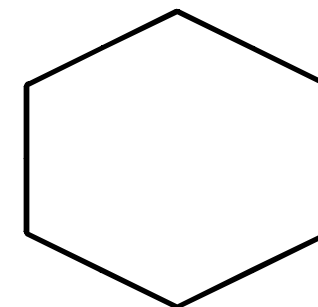
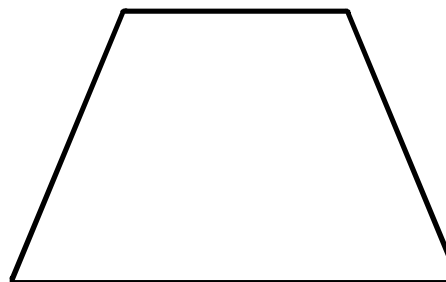
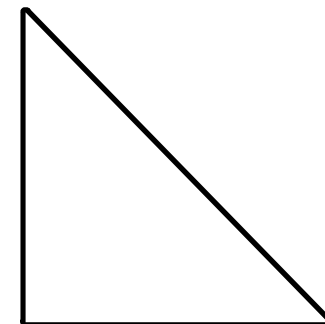
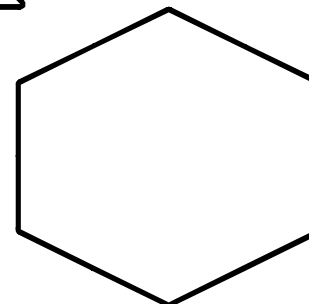
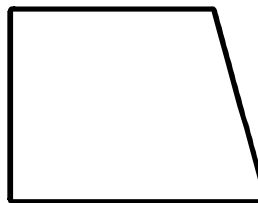
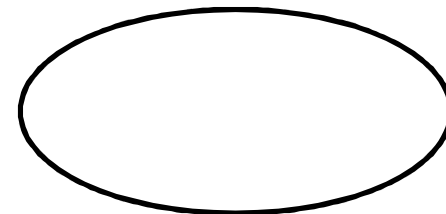
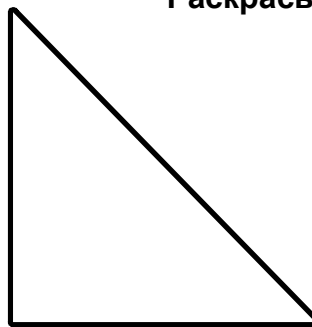

Какие цифры спрятались за тучками.

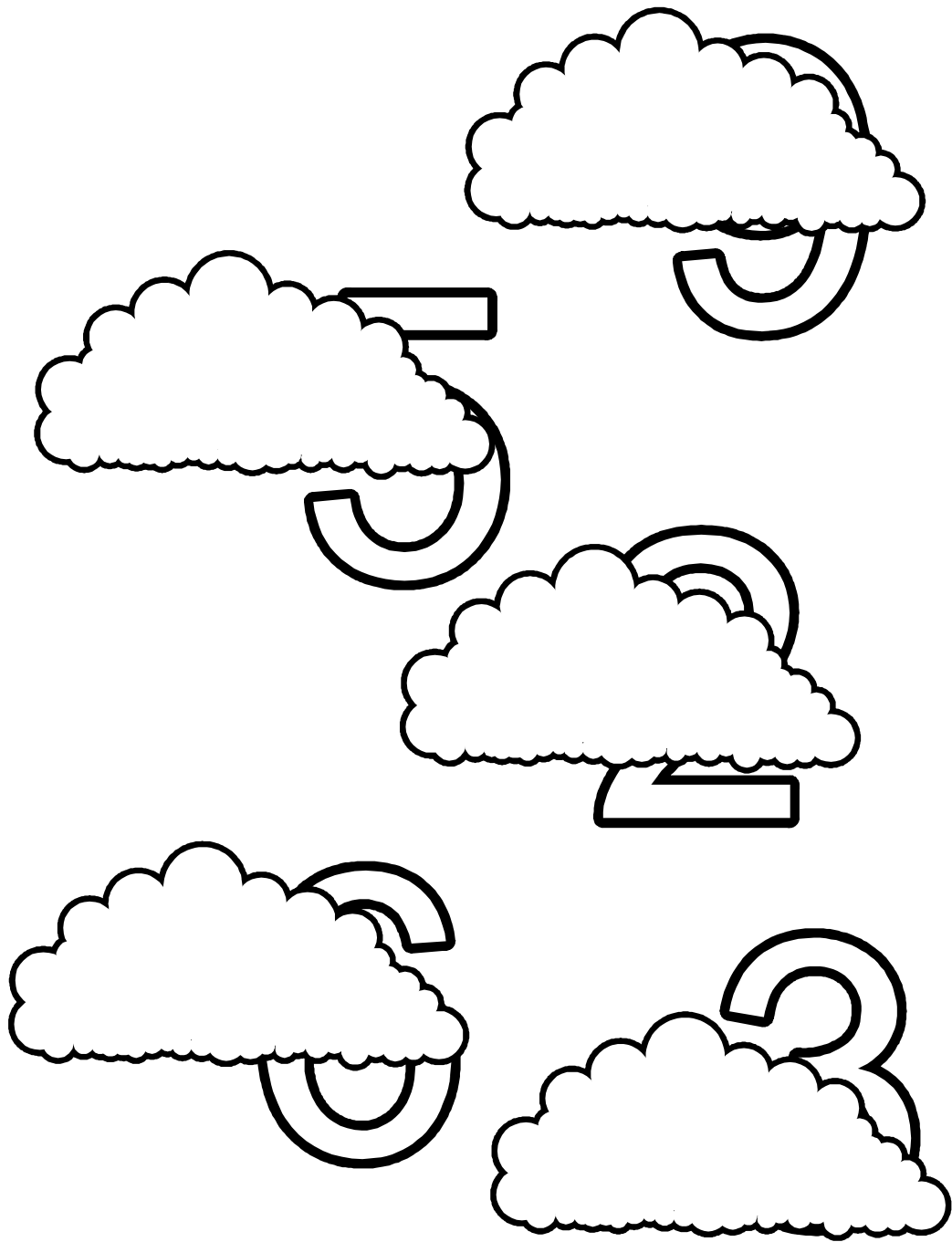

Дорисуй цифры.

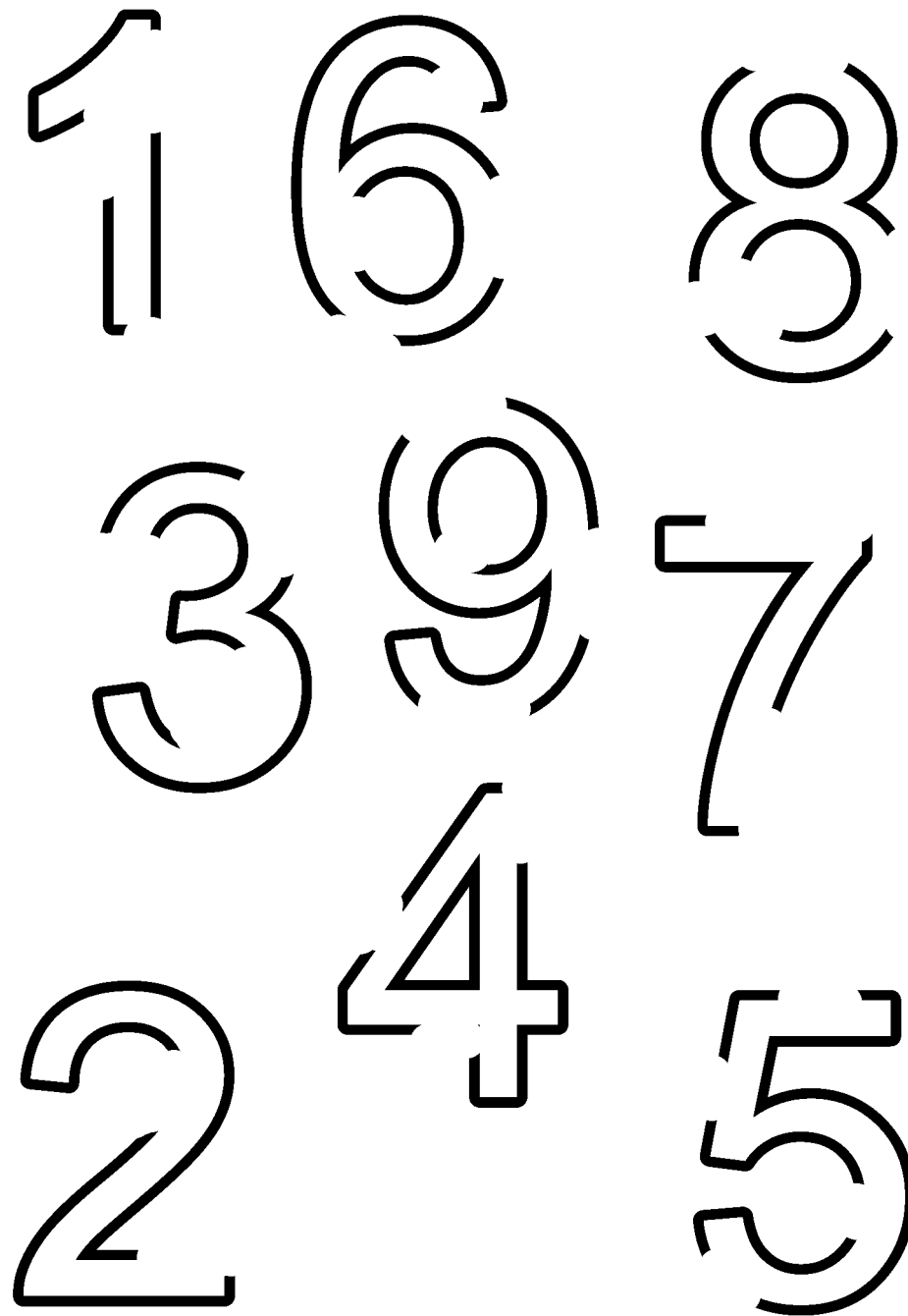

Нарисуй прямоугольники в пустых клеточках точно так же.

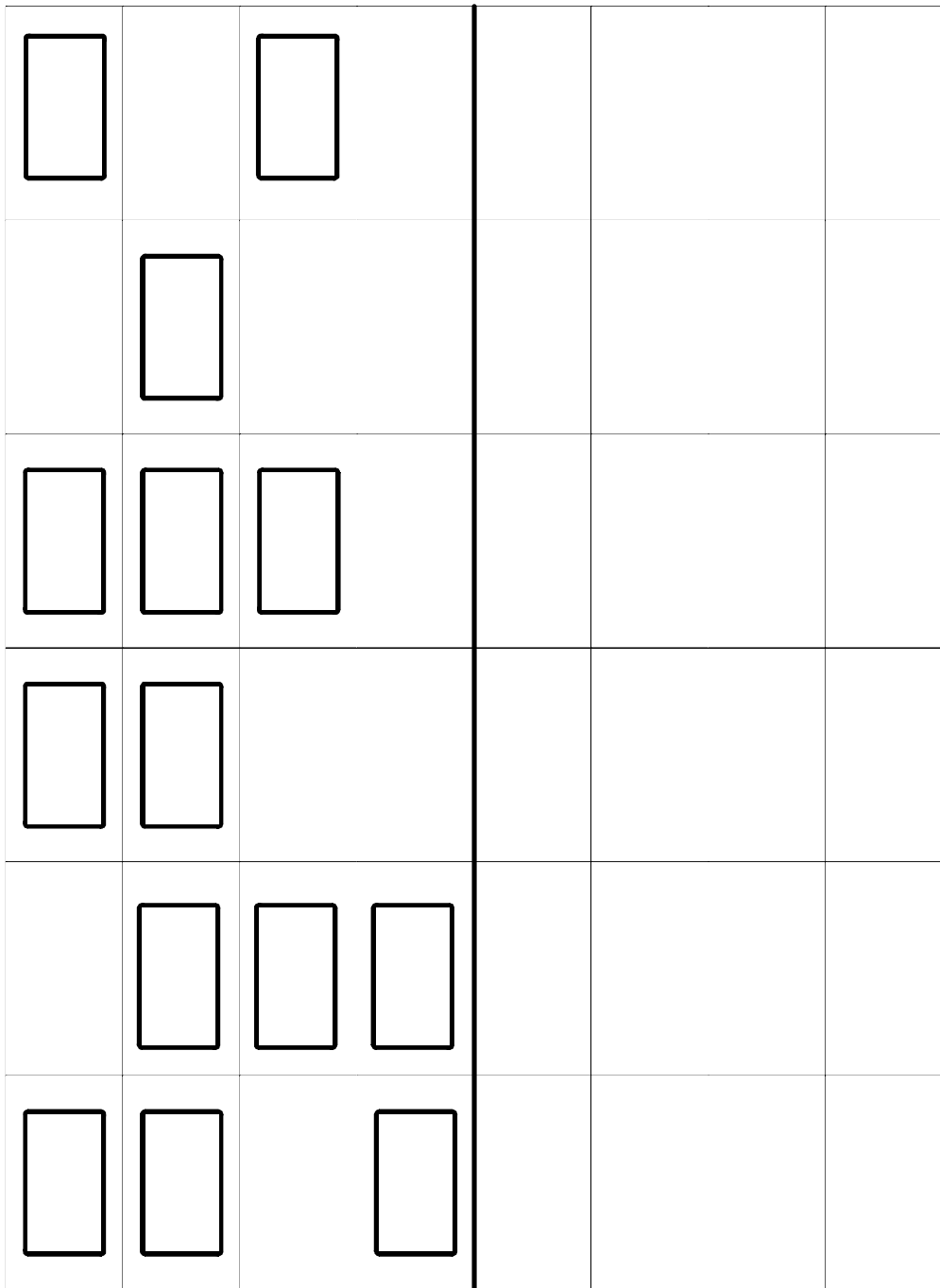

Нарисуй овалы в пустых клеточках точно так же.

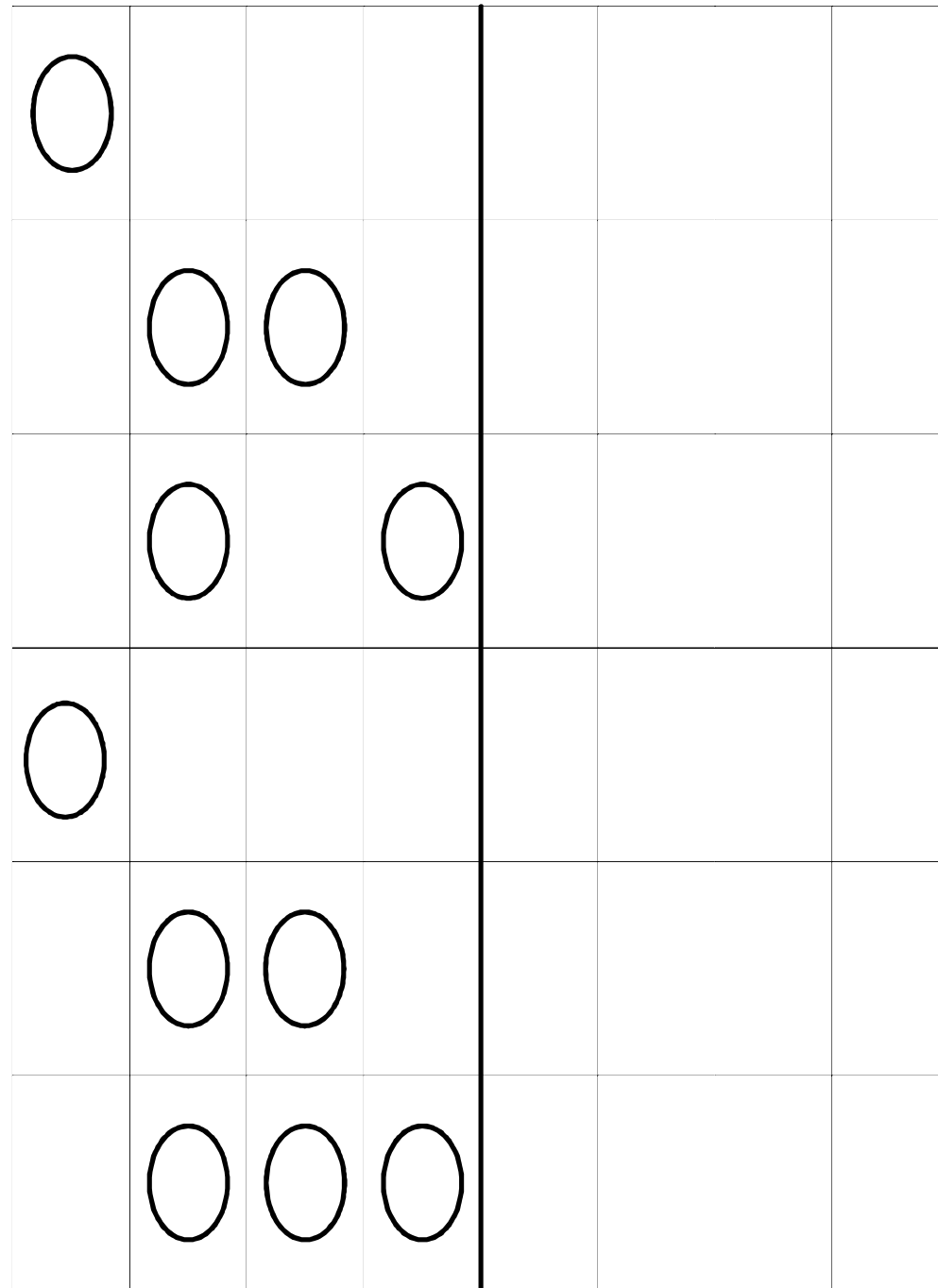



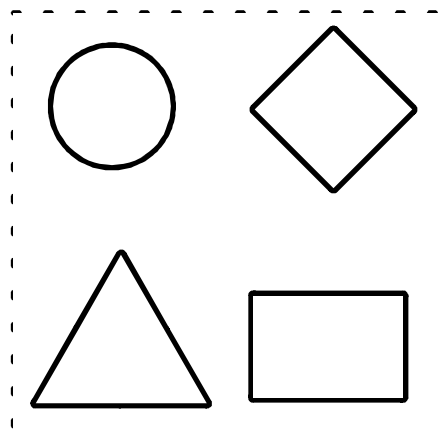
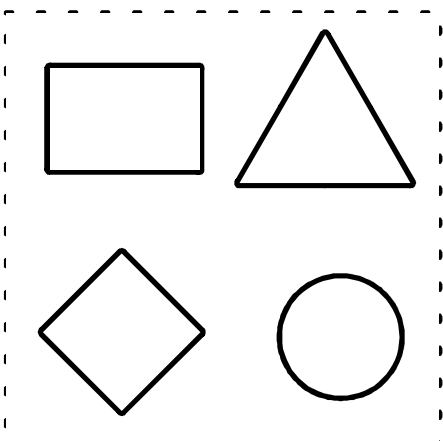
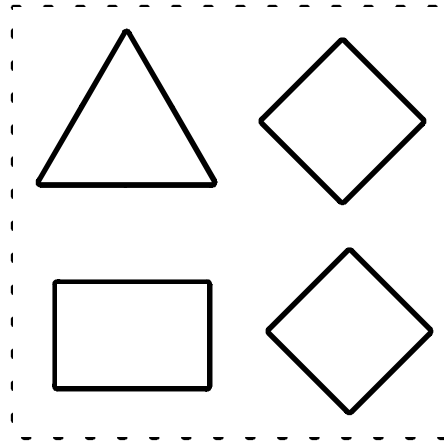
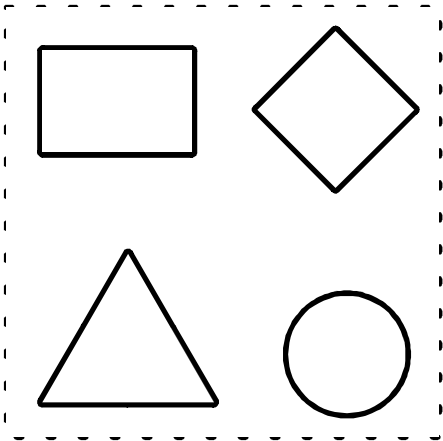
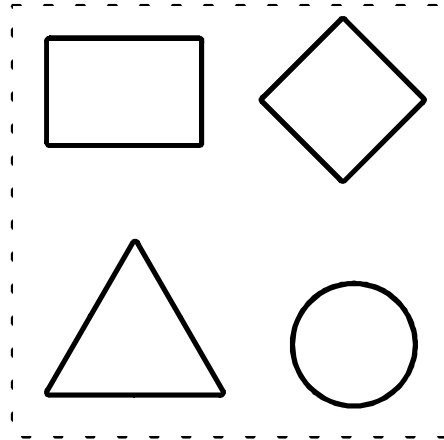
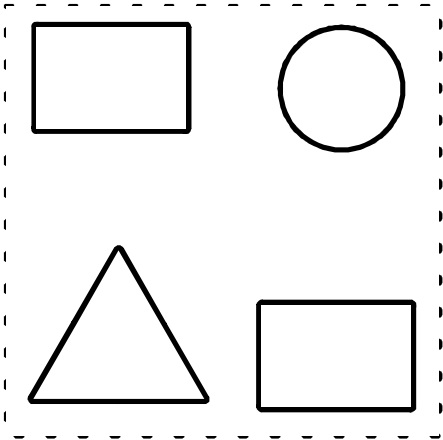

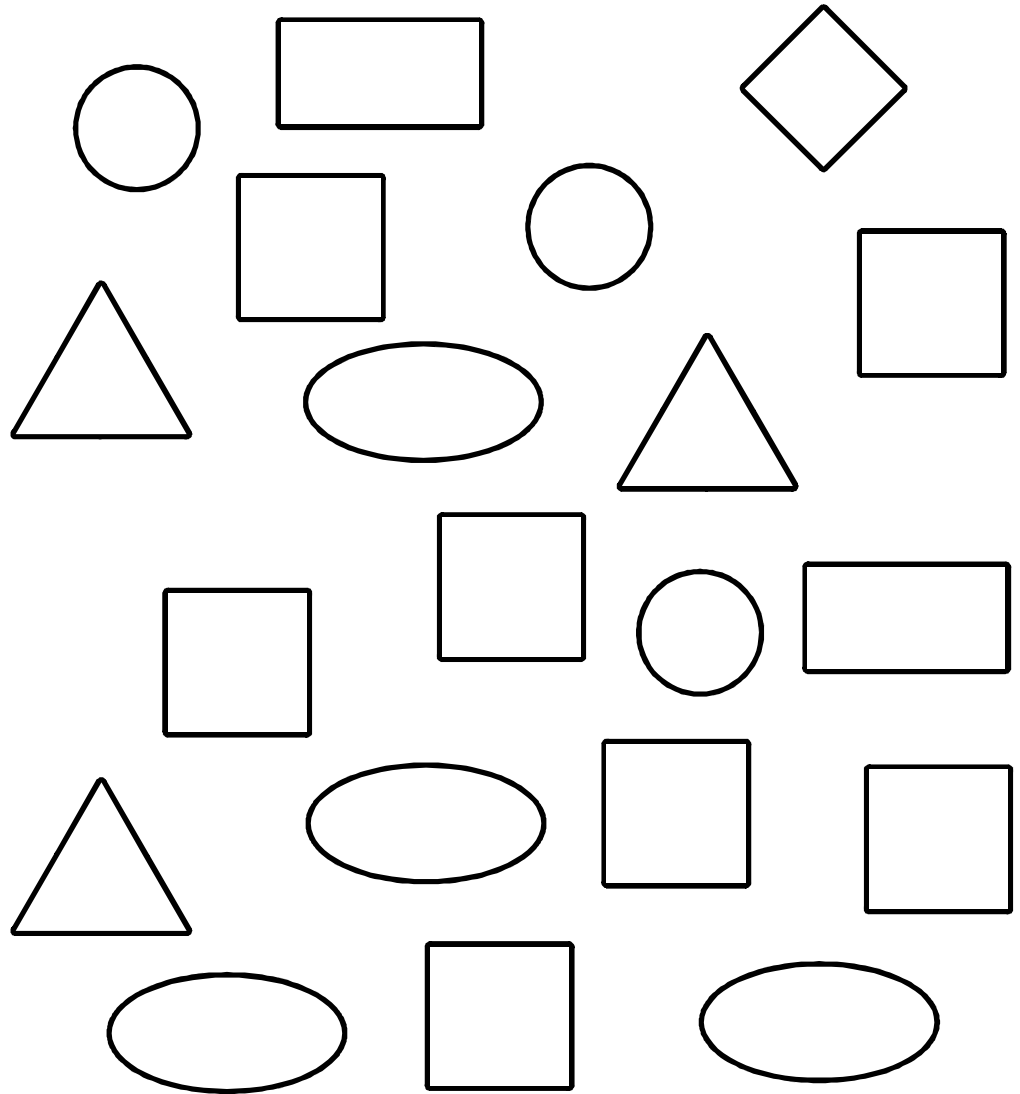

Найди одинаковые картинки.



Посчитай и запиши, сколько раз встречается каждая фигура.



Впиши пропущенные цифры.

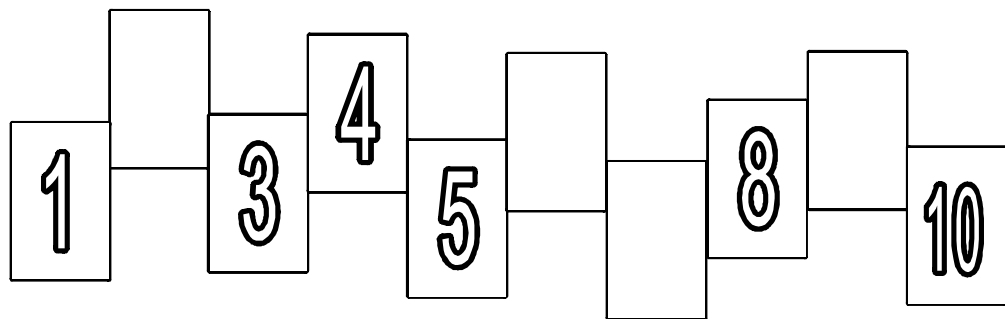
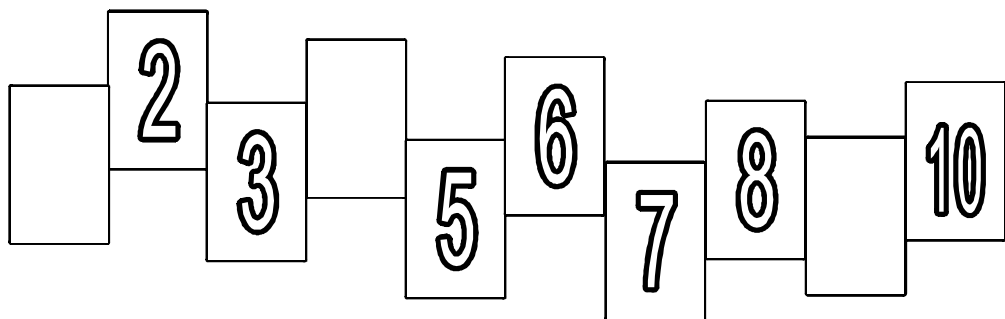
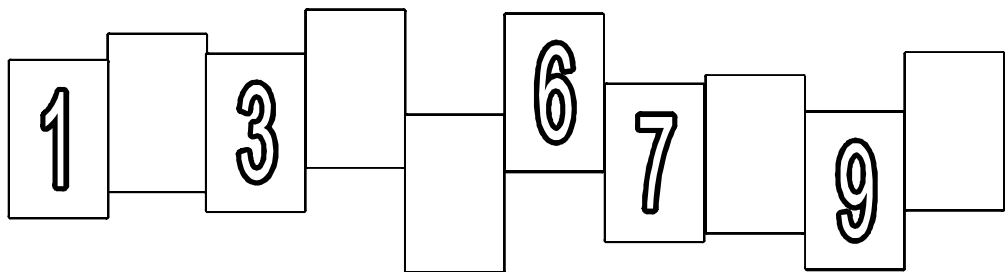
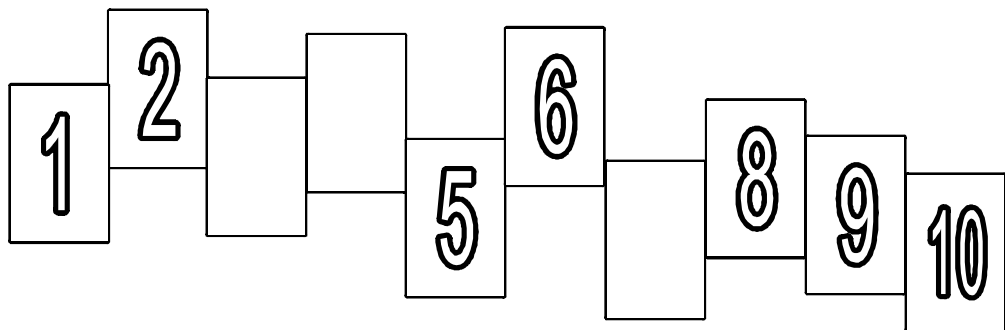

Что изменилось?

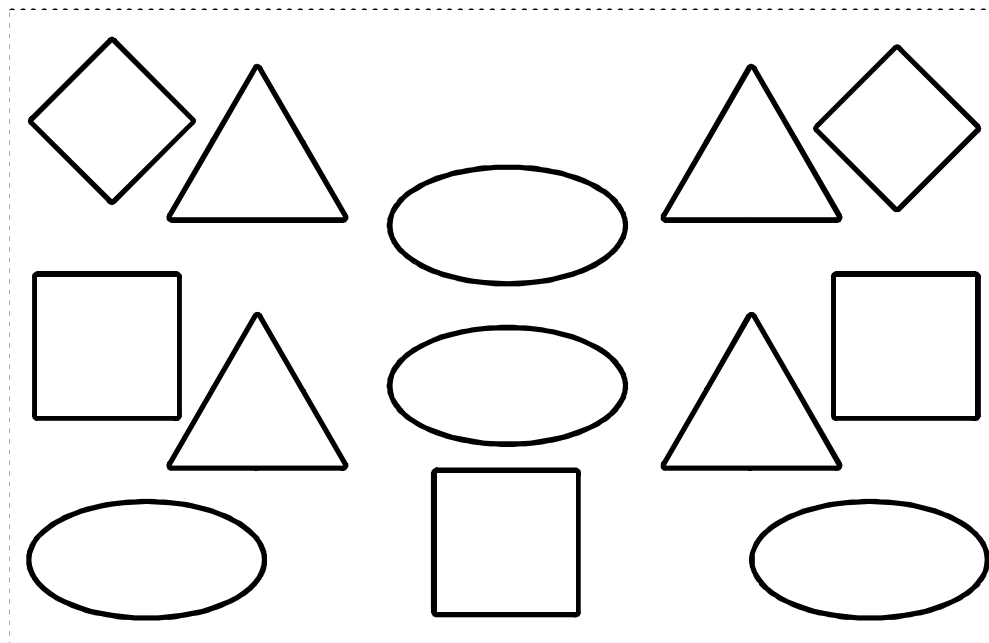
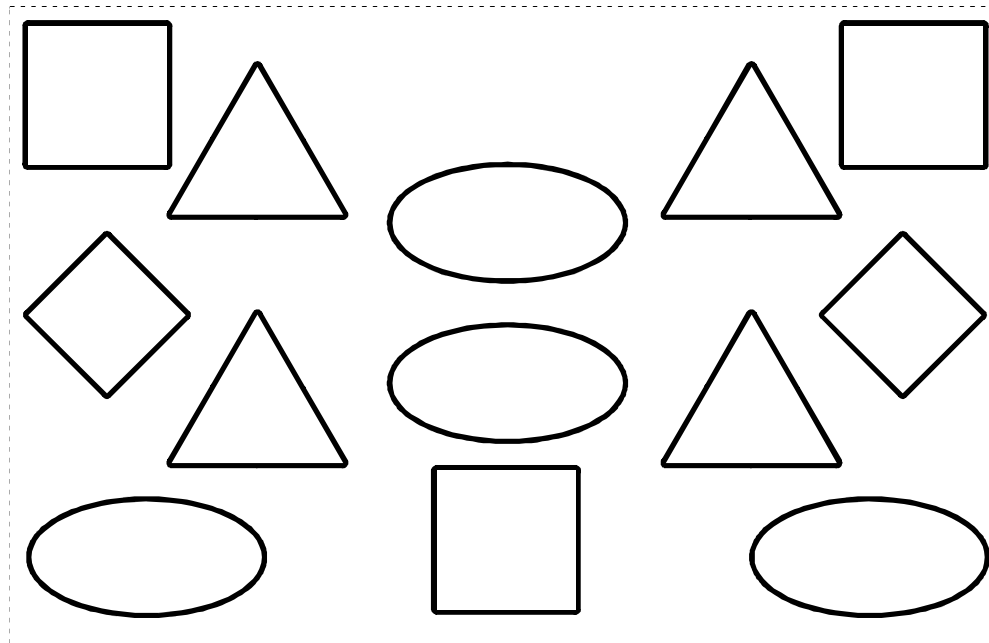

Соедини картинки с одинаковым количеством фигур.

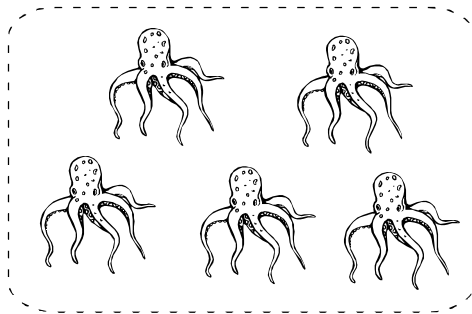
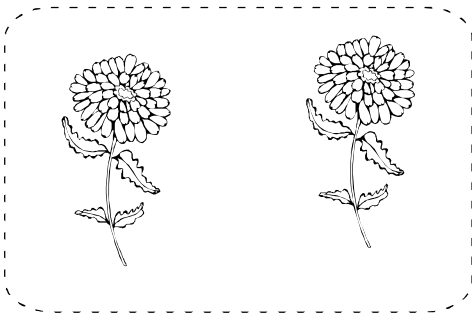
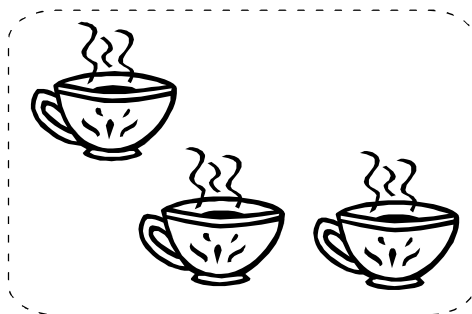
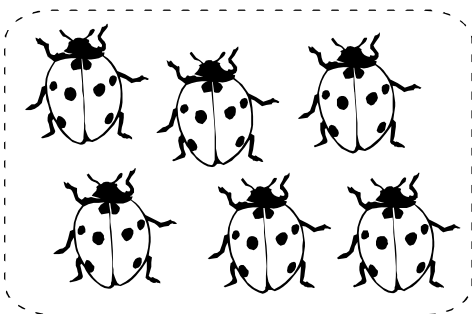
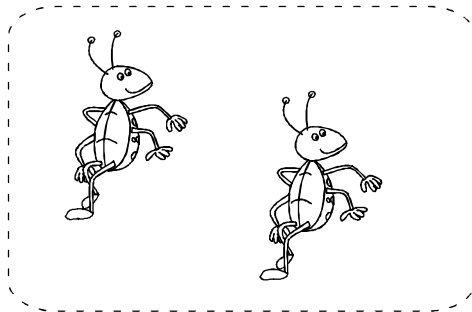
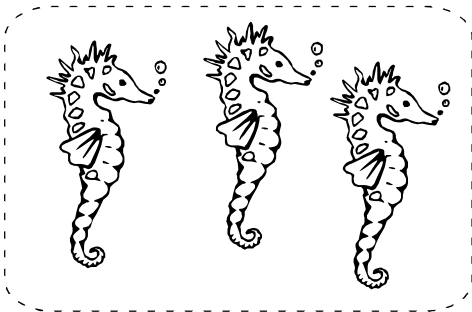
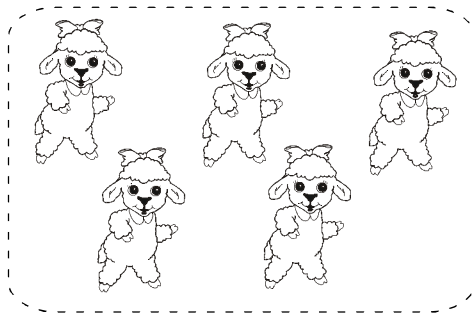
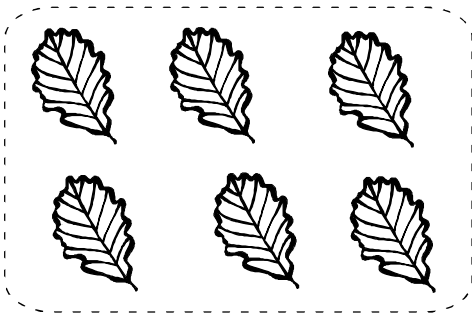

Нарисуй под картинками столько ромбиков, сколько предметов на картинке.

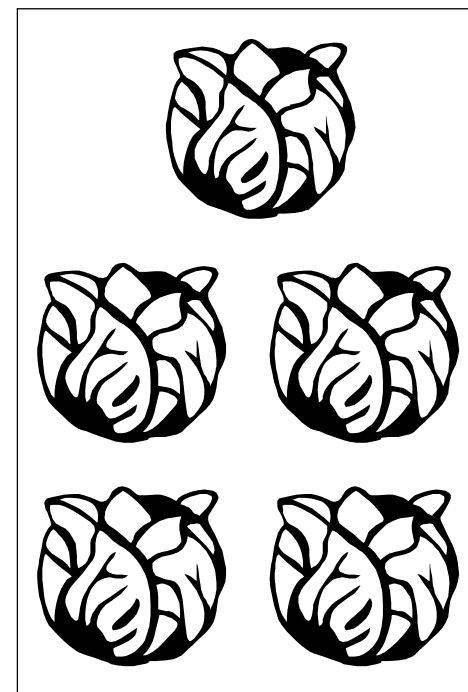
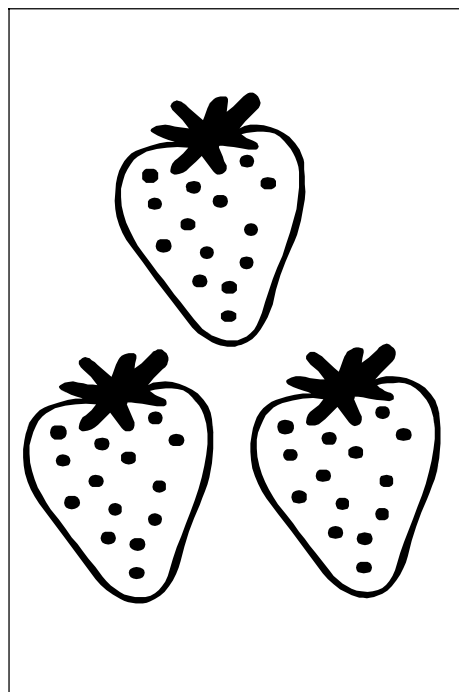
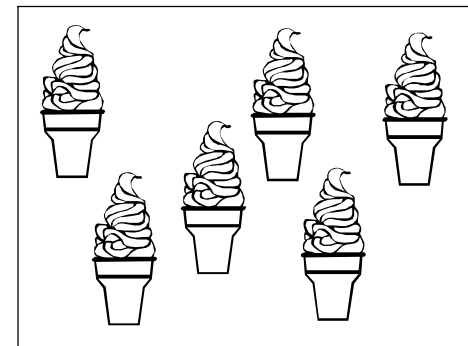
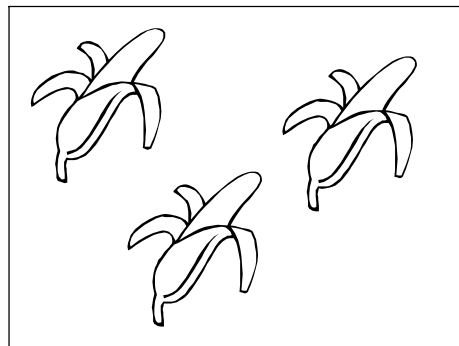

Покажи при помощи стрелок предметы от самого маленького до самого большого.

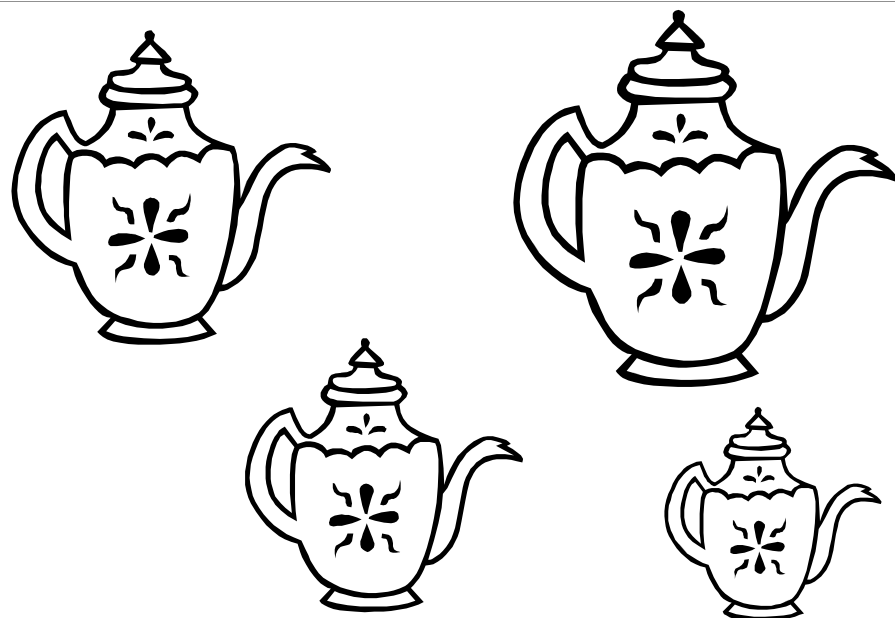
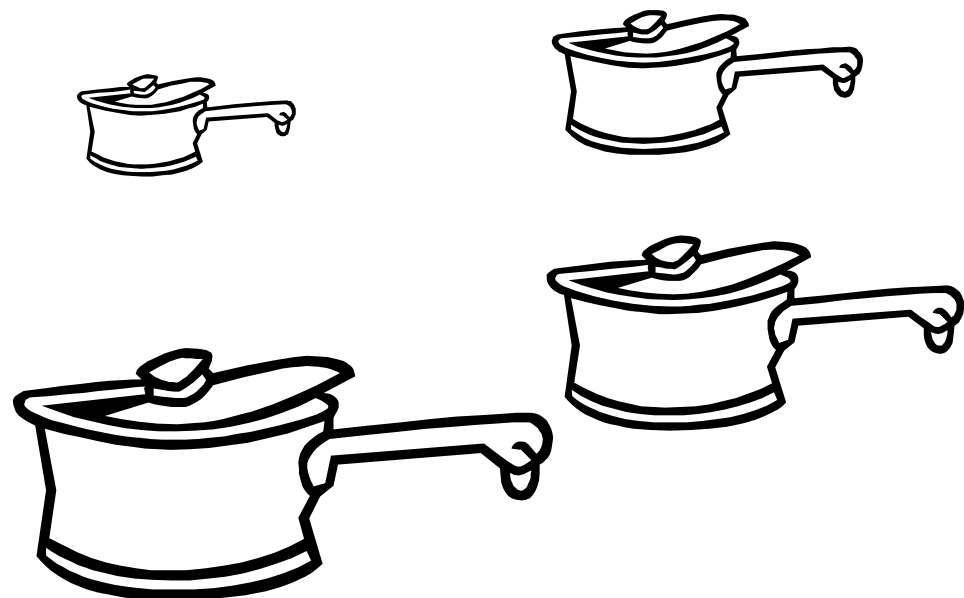

Дорисуй к каждому домику по дереву.
Сколько всего получилось деревьев?

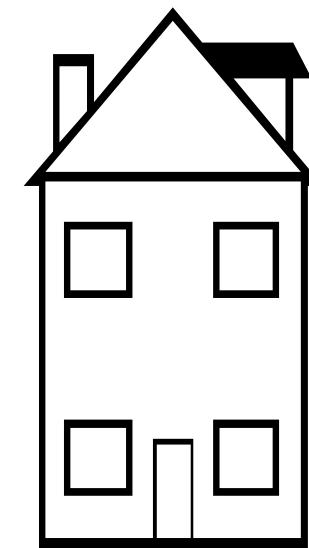
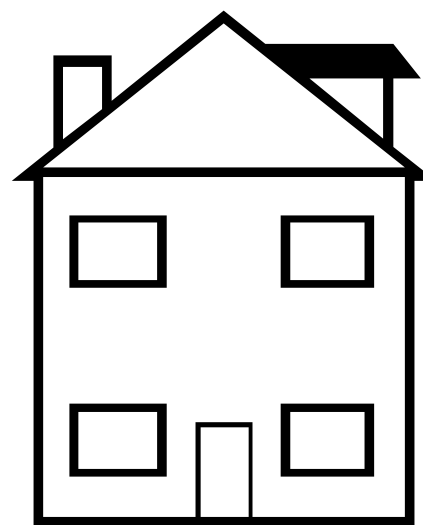
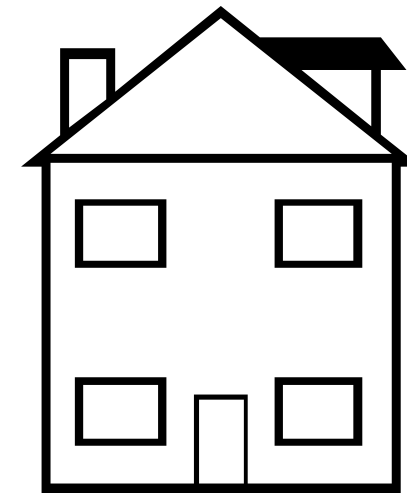
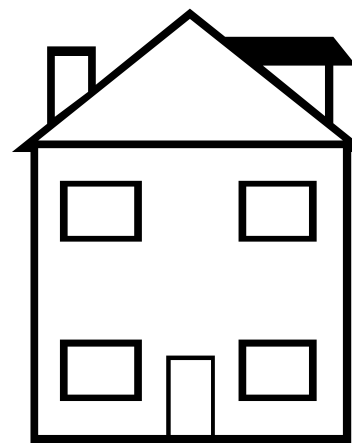

Нарисуй любых фигур столько, сколько обозначено цифрой.

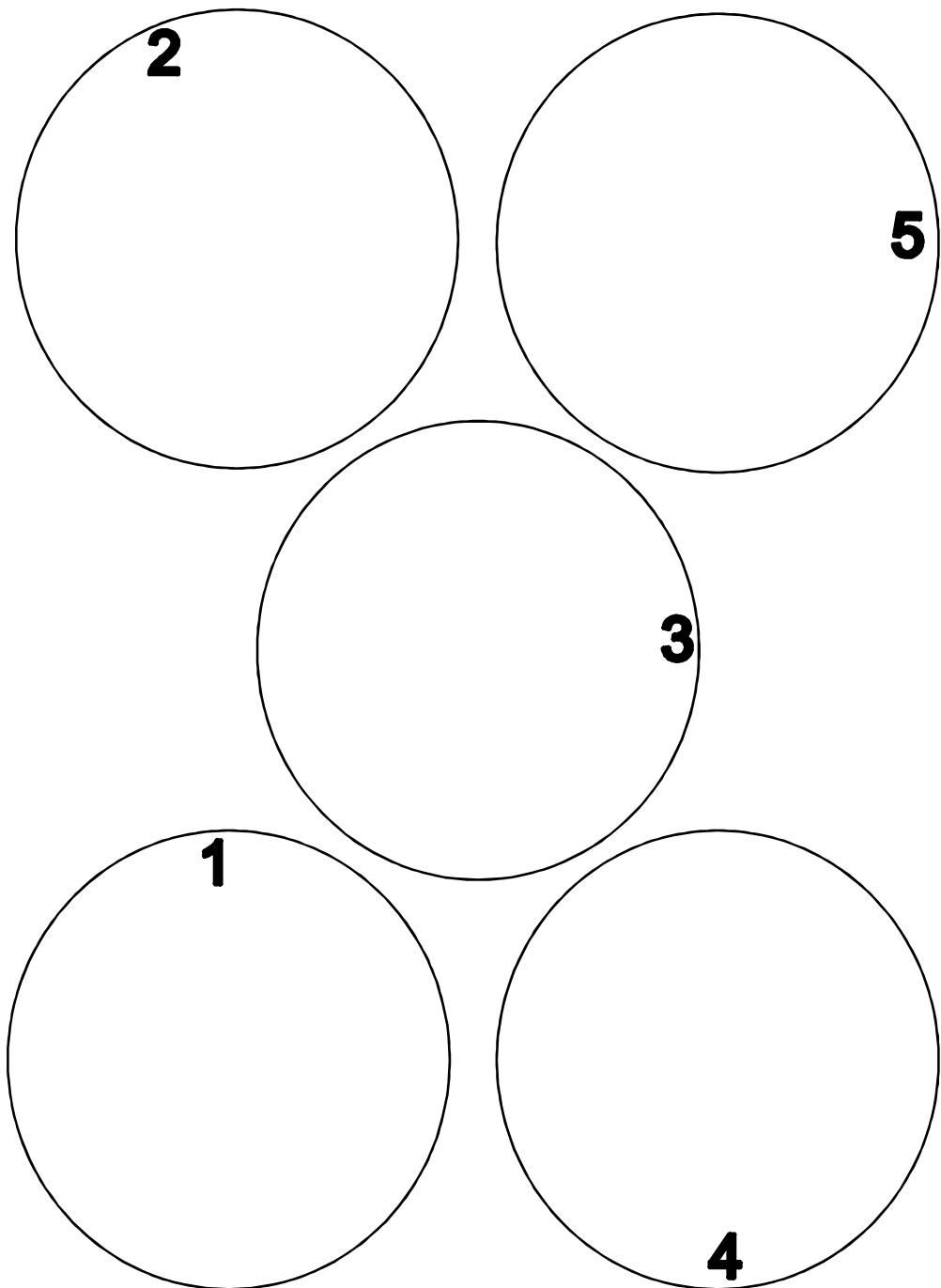

Найди и раскрась те предметы, которых по четыре.

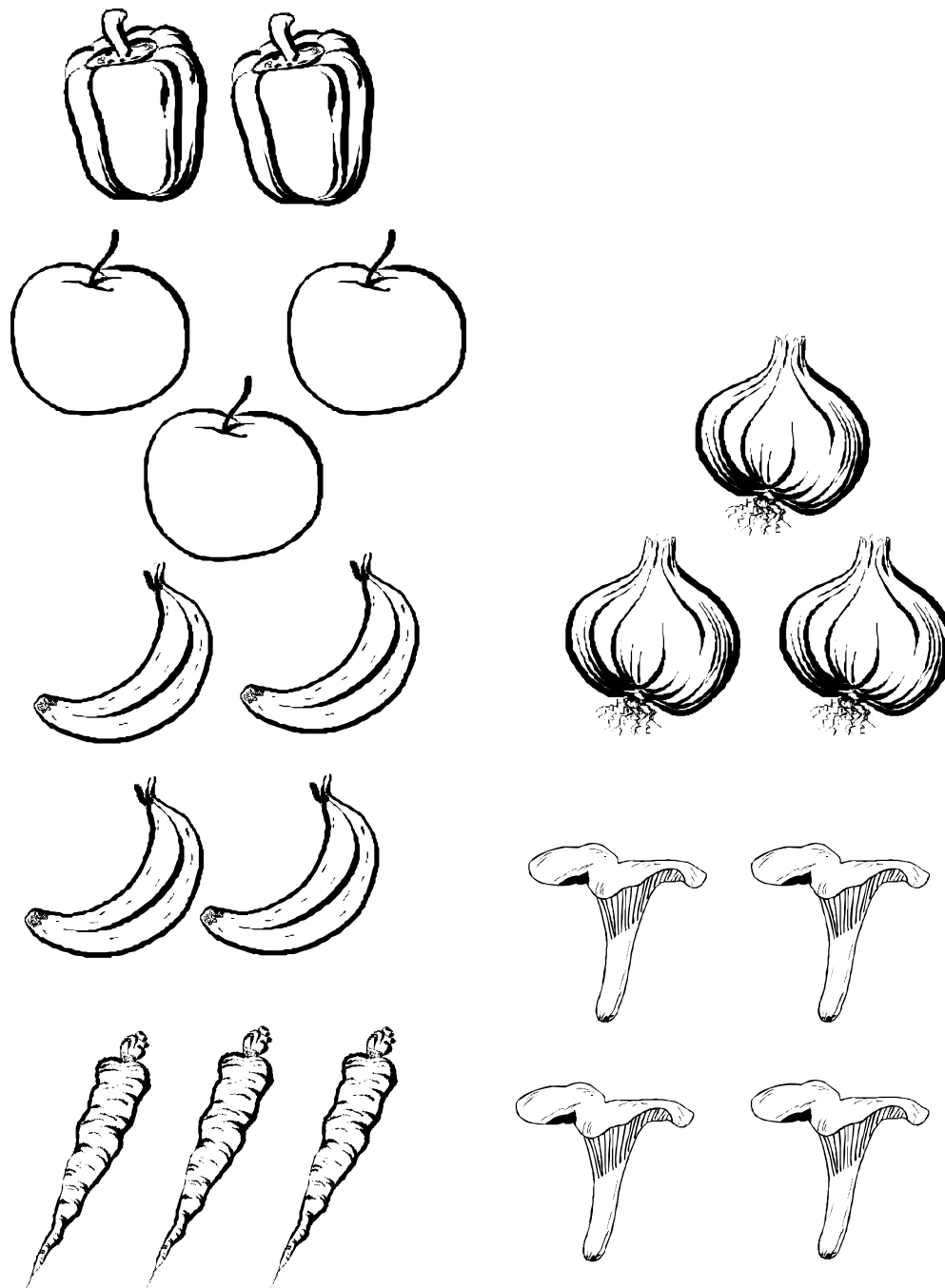

Дорисуй в каждом ряду фигурки, чтобы их было по пять.

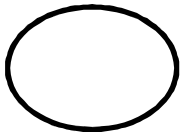
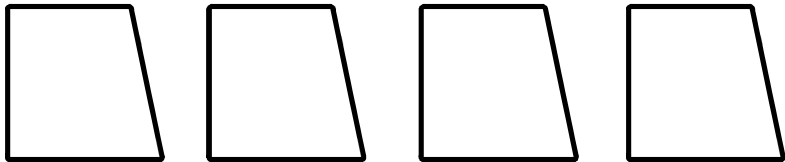
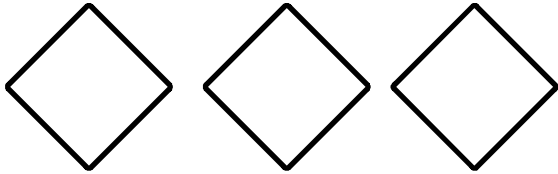
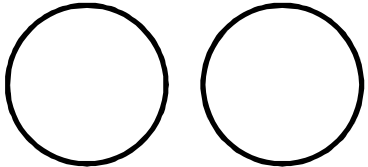
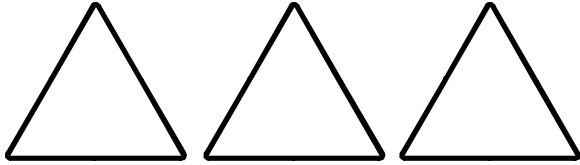
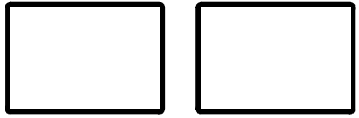

Зачеркни столько кругов, сколько тучек; столько ромбов, сколько шляпок; столько треугольников, сколько домиков.

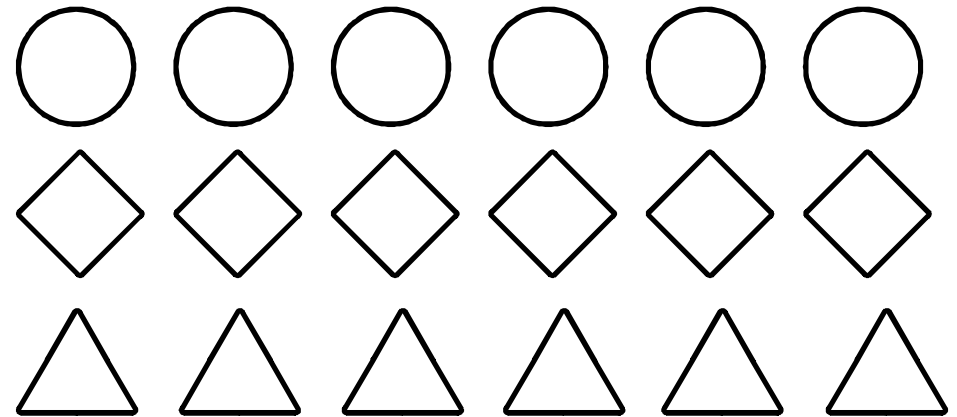
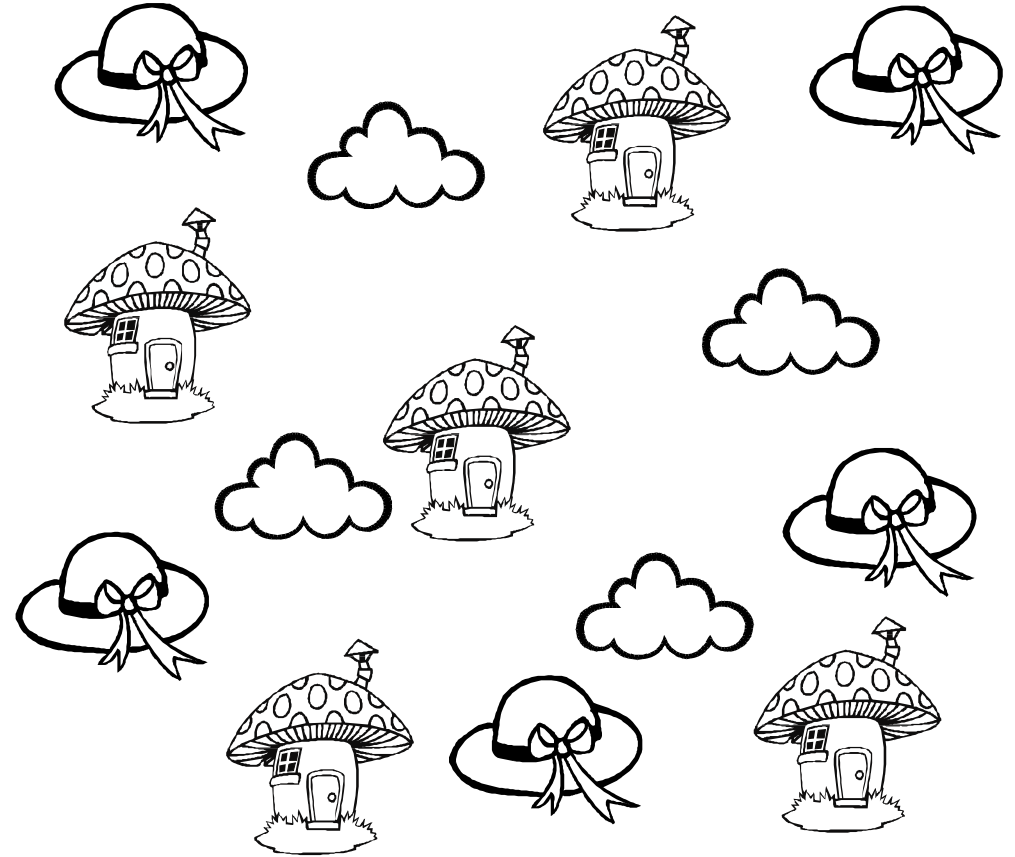

Соедини цифры по порядку стрелочками.

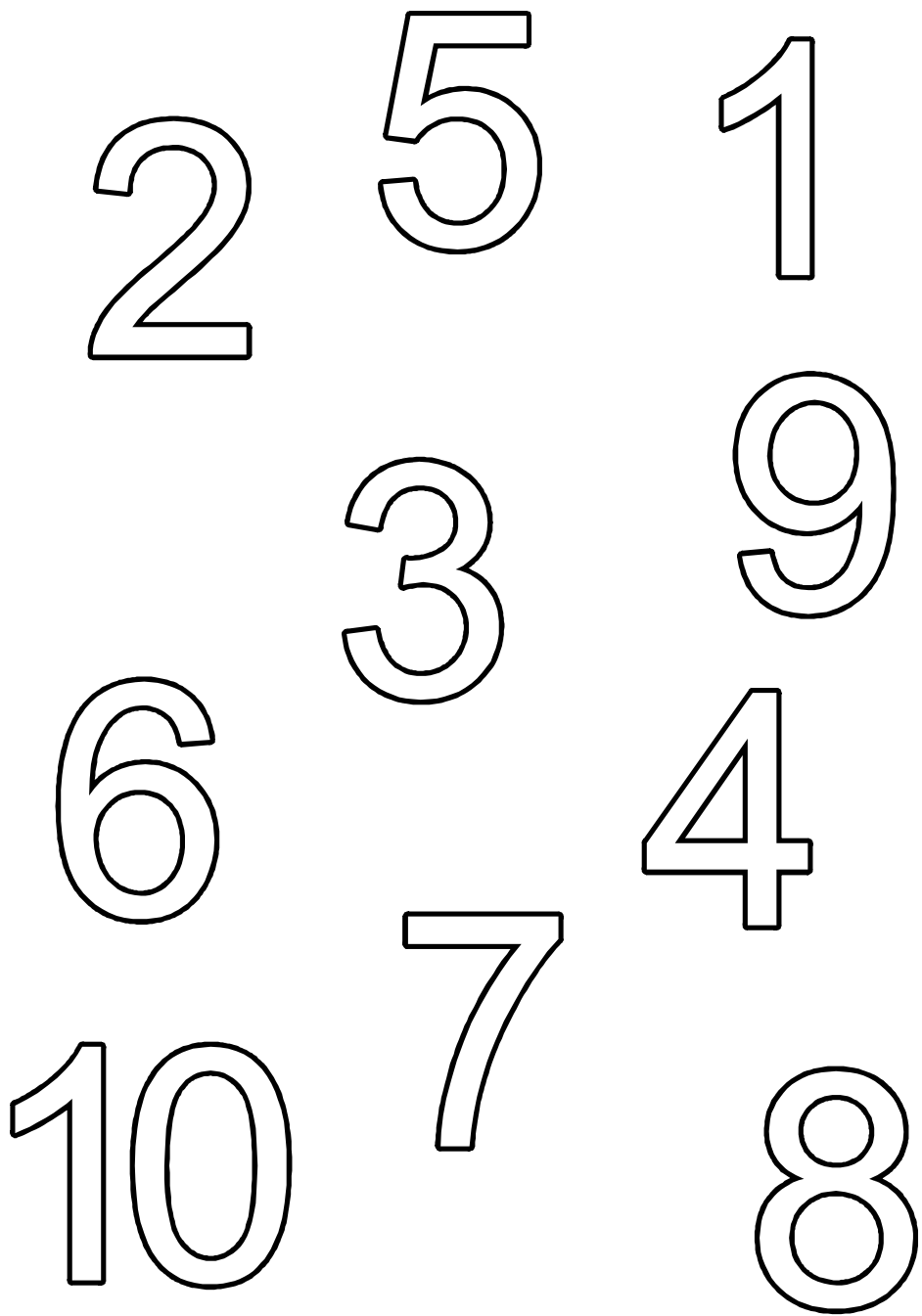

Нарисуй внизу овалов больше, чем сверху на два .

